



PRODUCT CATALOG 2025



Valencia

Lumber and Panel



*PROVIDING ONLY THE FINEST SELECTION OF
HARDWOODS, SOFTWOODS, PANELS, VENEERS, AND
ACCESSORIES TO THE PROFESSIONAL.
PROUDLY SERVING CONTRACTORS, CABINETMAKERS,
AND WOODWORKERS WITH DEDICATION SINCE 2000.*



CONTENTS

HARDWOODS ALDER, OAK, WALNUT...	3-19	ADHESIVES, ABRASIVES CONTACT, CAULK, FILLERS, SANDING DISCS...	53-56
DECKING IPE, MANGARIS, BAMBOO...	6	EDGE BANDING WOOD, PVC, TEXTURED...	57-62
SOFTWOODS, T&G CEDAR, HEMLOCK, SIDING...	20-26	FINISHES INTERIOR, EXTERIOR, DECKING...	63-72
RECLAIMED, LIVE EDGE NATURE AGED GREY, BOXED THINS...	27-30	CABINET ORGANIZATION LAZY SUSANS, TRASH PULL-OUTS...	73-75
PANELS, VENEERS RIFT WHITE OAK, QUARTER SAWN WALNUT...	31-43	CLOSET, SHELVING CLOSET ROD, PRE-CUT SHELVING...	76-77
PLYWOOD CDX, ACX, MARINE, FLEX...	44	SLIDES, HINGES HETTICH SLIDES & HINGES...	78-81
MDF ULTRA LITE, HDM, EXTIRA, MEDEX...	45	DECKING STUFF SCREWS, CLIPS, PLUGS, JOIST TAPE...	82-83
MELAMINE, FORMICA TEXTURED, PRE-CUT, POST FORMING...	46-50	MICELLANEOUS STUFF BITS, BISCUITS, SHIMS, SHELF PINS...	84-85
FASTENERS STAPLES, BRADS, SCREWS...	51-52	CMT ORANGE TOOLS BLADES, ROUTER BITS, SHAPER CUTTERS...	86-97



Valencia
Lumber and Panel

15809 STRATHERN STREET • VAN NUYS CA • 91406



818-786-5800



SALES@VALENCIALUMBER.COM



WWW.VALENCIALUMBER.COM



HARDWOODS

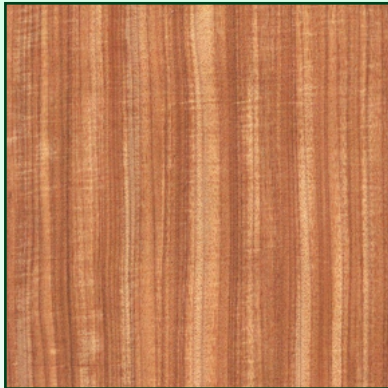

AFRORMOSIA

QUARTER SAWN ▪ FAS

4/4 ROUGH 104-000-000

4/4 S2S & SL1E 104-000-010

8/4 ROUGH 104-060-000

8/4 S2S & SL1E 104-060-010



ALDER

PLAIN SAWN ▪ FAS

4/4 SUPERIOR BLANKED 105-015-000

4/4 SUPERIOR S2S & SL1E 105-015-010

5/4 SUPERIOR BLANKED 105-035-000

5/4 SUPERIOR S2S & SL1E 105-035-010

6/4 SUPERIOR BLANKED 105-040-000

6/4 SUPERIOR S2S & SL1E 105-040-010

8/4 SUPERIOR BLANKED 105-060-000

8/4 SUPERIOR S2S & SL1E 105-060-010

12/4 SUPERIOR BLANKED 105-080-000

12/4 SUPERIOR S2S & SL1E 105-080-010

PLAIN SAWN ▪ PREMIUM FRAME

4/4 BLANKED 105-030-000

4/4 S2S & SL1E 105-030-010

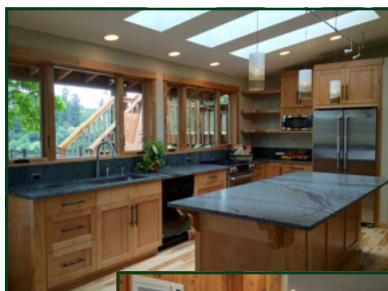

Valencia
Lumber and Panel

15809 STRATHERN STREET • VAN NUYS CA • 91406

818-786-5800

SALES@VALENCIALUMBER.COM

WWW.VALENCIALUMBER.COM



*FUN FACT:
THE WORLD IS HOME TO MORE THAN
73,000 SPECIES OF TREES.*

HARDWOODS



ASH

PLAIN SAWN ▪ FAS

4/4 ROUGH 107-000-000

4/4 S2S & SL1E 107-000-010



BEECH

PLAIN SAWN ▪ EURO STEAMED ▪ FAS

4/4 ROUGH 110-000-000

4/4 S2S & SL1E 110-000-010

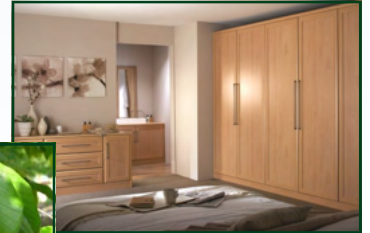

BIRCH

PLAIN SAWN ▪ SELECT & BETTER ▪ NATURAL

4/4 ROUGH 112-025-000

4/4 S2S & SL1E 112-025-010

8/4 ROUGH 112-040-000

8/4 S2S & SL1E 112-040-010



Valencia
Lumber and Panel

15809 STRATHERN STREET • VAN NUYS CA • 91406

☎ 818-786-5800

✉ SALES@VALENCIALUMBER.COM

🌐 WWW.VALENCIALUMBER.COM



HARDWOODS



BUBINGA

PLAIN SAWN ▪ FAS

4/4 S2S & SL1E 114-500-010



CHERRY

PLAIN SAWN ▪ FAS

4/4 ROUGH 116-000-000

4/4 S2S & SL1E 116-000-010

5/4 ROUGH 116-020-000

5/4 S2S & SL1E 116-020-010

6/4 ROUGH 116-025-000

6/4 S2S & SL1E 116-025-010

8/4 ROUGH 116-030-000

8/4 S2S & SL1E 116-030-010



Valencia
Lumber and Panel

15809 STRATHERN STREET • VAN NUYS CA • 91406

 818-786-5800

 SALES@VALENCIALUMBER.COM

 WWW.VALENCIALUMBER.COM



HARDWOODS



DECK CLIPS & SCREWS ON PAGE 92

IPE

SURFACE 4 SIDES & EASED 4 EDGES

- 1 x 4 137-052-008
- 1 x 6 137-050-001
- 5/4 x 6 137-050-022
- 2 x 4 137-055-000
- 2 x 6 137-060-007
- 2 x 8 137-063-008
- 4 x 4 137-070-003

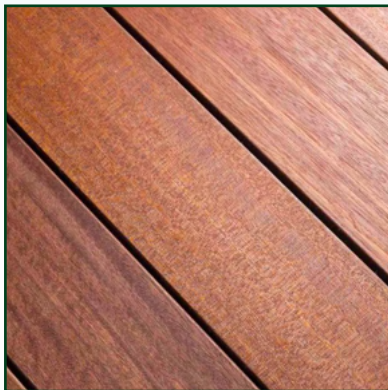

MANGARIS (RED BALAU)

SURFACE 4 SIDES & EASED 4 EDGES

- 1 x 6 109-001-196

DECK FINISHES ON PAGES 69, 70, & 87.



MOSO

- MOSO X-TREME BAMBOO DECKING**
 1 x 6 x 6' 802-179-035
 CLIPS 802-779-361



TREX AND OTHER DECKING CHOICES ARE ALSO AVAILABLE.
 PLEASE CONTACT OUR SALES DEPARTMENT FOR INFO.



15809 STRATHERN STREET • VAN NUYS CA • 91406

818-786-5800

SALES@VALENCIALUMBER.COM

WWW.VALENCIALUMBER.COM



HARDWOODS



LACEWOOD

4/4 FAS S2S & SL1E 145-000-010



MAHOGANY - AFRICAN

MIXED GRAIN - FAS

4/4 ROUGH 150-017-000

4/4 S2S & SL1E 150-017-010

5/4 ROUGH 150-027-000

5/4 S2S & SL1E 150-027-010

6/4 ROUGH 150-038-000

6/4 S2S & SL1E 150-038-010

8/4 ROUGH 150-053-000

8/4 S2S & SL1E 150-053-010

12/4 ROUGH 150-070-000

12/4 S2S & SL1E 150-070-010

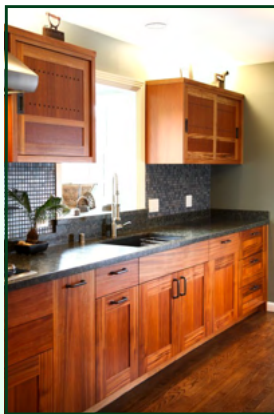

Valencia
Lumber and Panel

15809 STRATHERN STREET • VAN NUYS CA • 91406

818-786-5800

SALES@VALENCIALUMBER.COM

WWW.VALENCIALUMBER.COM



*FUN FACT:
BALSA, THE WORLD'S SOFTEST WOOD,
IS ACTUALLY A HARDWOOD.*

HARDWOODS



MAHOGANY ▪ HONDURAN

PATTERN GRADE ▪ FAS

4/4 ROUGH 153-000-000

4/4 S2S & SL1E 153-000-010

8/4 ROUGH 153-035-000



MAPLE ▪ HARD

PLAIN SAWN WHITE ▪ FAS

4/4 ROUGH 160-000-000

4/4 S2S & SL1E 160-000-010

5/4 ROUGH 160-020-000

5/4 S2S & SL1E 160-020-010

6/4 ROUGH 160-030-000

6/4 S2S & SL1E 160-050-010

8/4 ROUGH 160-045-000

8/4 S2S & SL1E 160-045-010

12/4 ROUGH 160-050-000

12/4 S2S & SL1E 160-050-010

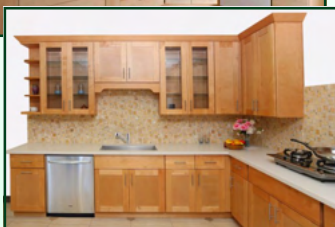

QUARTER SAWN AND WIDE STOCK OFTEN AVAILABLE.
PLEASE CONTACT OUR SALES DEPARTMENT FOR INFO.



Valencia
Lumber and Panel

15809 STRATHERN STREET • VAN NUYS CA • 91406

818-786-5800

SALES@VALENCIALUMBER.COM

WWW.VALENCIALUMBER.COM



HARDWOODS



MAPLE ▪ SOFT

WHITE ▪ PLAIN SAWN ▪ FAS

1/2" S2S & SL1E 162-000-010

4/4 ROUGH 162-010-000

4/4 S2S & SL1E 162-010-010

5/4 ROUGH 162-030-000

5/4 S2S & SL1E 162-030-010

6/4 ROUGH 162-040-000

6/4 S2S & SL1E 162-040-010

8/4 ROUGH 162-050-000

8/4 S2S & SL1E 162-050-010

12/4 ROUGH 162-070-000

12/4 S2S & SL1E 162-070-010

NATURAL ▪ PLAIN SAWN ▪ FAS

4/4 ROUGH 162-020-000

4/4 S2S & SL1E 162-020-010

CURLY ▪ PLAIN SAWN ▪ FAS

4/4 S2S & SL1E 162-025-010

5/4 S2S & SL1E 162-035-010

IF YOU CAN'T FIND WHAT YOU'RE LOOKING FOR, WHETHER IT'S A PARTICULAR SPECIES, OR MAYBE A THICKNESS, OR JUST NEED CERTAIN LENGTHS FOR THAT JOB, PLEASE DON'T HESITATE TO CONTACT OUR SALES DEPARTMENT WITH YOUR REQUESTS. WE HAVE TRUCKS COMING AND GOING TO OUR MILLS REGULARLY AND IT MAY JUST BE A PHONE CALL AWAY.

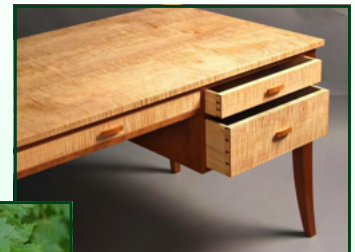

Valencia
Lumber and Panel

15809 STRATHERN STREET • VAN NUYS CA • 91406

818-786-5800

SALES@VALENCIALUMBER.COM

WWW.VALENCIALUMBER.COM



HARDWOODS



RED OAK

PLAIN SAWN ▪ FAS

4/4 ROUGH 170-000-000

4/4 S2S & SL1E 170-000-010

5/4 ROUGH 170-025-000

5/4 S2S & SL1E 170-025-010

6/4 ROUGH 170-045-000

6/4 S2S & SL1E 170-045-010

8/4 ROUGH 170-050-000

8/4 S2S & SL1E 170-050-010

12/4 ROUGH 170-060-000

12/4 S2S & SL1E 170-060-010



WIDE STOCK ALSO AVAILABLE.
PLEASE CONTACT OUR SALES DEPARTMENT FOR INFO.

HOBBY LENGTHS

24" - 48" LENGTHS OF OUR MOST POPULAR HARDWOODS



EVERYTHING YOU NEED TO WORK
YOUR WOOD CAN BE FOUND ON
PAGES PAGE 87-98.



Valencia
Lumber and Panel

15809 STRATHERN STREET • VAN NUYS CA • 91406

*FUN FACT:
ONE SQUARE INCH OF SUPER GLUE CAN
SUPPORT 1000 POUNDS OF WEIGHT.*

818-786-5800

SALES@VALENCIALUMBER.COM

WWW.VALENCIALUMBER.COM



HARDWOODS



PLAIN SAWN



WHITE OAK - PLAIN SAWN

PLAIN SAWN - FAS

4/4 ROUGH 175-000-000

4/4 S2S & SL1E 175-000-010

5/4 ROUGH 175-040-000

5/4 S2S & SL1E 175-040-010

6/4 ROUGH 175-055-000

6/4 S2S & SL1E 175-055-010

8/4 ROUGH 175-070-000

8/4 S2S & SL1E 175-070-010

10/4 ROUGH 175-085-000

10/4 S2S & SL1E 175-085-010

12/4 ROUGH 175-090-000

12/4 S2S & SL1E 175-090-010

PLAIN SAWN - RUSTIC

4/4 ROUGH 175-035-000

4/4 S2S & SL1E 175-035-010



WIDE STOCK ALSO AVAILABLE
PLEASE CONTACT OUR SALES DEPARTMENT FOR INFO.

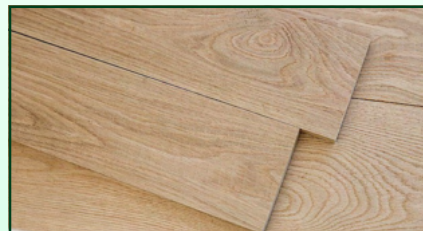

Valencia
Lumber and Panel

15809 STRATHERN STREET • VAN NUYS CA • 91406

 818-786-5800

 SALES@VALENCIALUMBER.COM

 WWW.VALENCIALUMBER.COM



HARDWOODS



RIFT SAWN



WHITE OAK - RIFT SAWN

RIFT SAWN - FAS

4/4 ROUGH 174-500-000

4/4 S2S & SL1E 174-500-010

5/4 ROUGH 174-530-000

5/4 S2S & SL1E 174-530-010

6/4 ROUGH 174-540-000

6/4 S2S & SL1E 174-540-010

8/4 ROUGH 174-550-000

8/4 S2S & SL1E 174-550-010



WIDE STOCK ALSO AVAILABLE
PLEASE CONTACT OUR SALES DEPARTMENT FOR INFO.

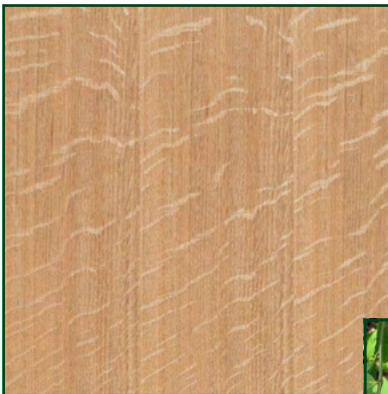

QUARTER SAWN



WHITE OAK - QUARTERED

QUARTER SAWN - FAS

4/4 ROUGH 174-700-000

4/4 S2S & SL1E 174-700-010



Valencia
Lumber and Panel

15809 STRATHERN STREET • VAN NUYS CA • 91406



818-786-5800



SALES@VALENCIALUMBER.COM



WWW.VALENCIALUMBER.COM



HARDWOODS



POPLAR

PLAIN SAWN ▪ FAS

4/4 ROUGH	180-000-000
4/4 S2S & SL1E	180-000-010
5/4 ROUGH	180-020-000
5/4 S2S & SL1E	180-020-010
6/4 ROUGH	180-030-000
6/4 S2S & SL1E	180-030-010
8/4 ROUGH	180-040-000
8/4 S2S & SL1E	180-040-010
10/4 ROUGH	180-050-000
10/4 S2S & SL1E	180-050-010
12/4 ROUGH	180-060-000
12/4 S2S & SL1E	180-060-010

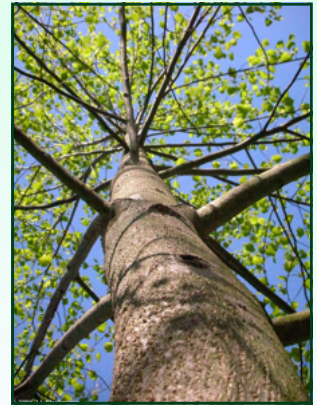

WIDE STOCK OFTEN AVAILABLE AND IN STOCK.
PLEASE CONTACT OUR SALES DEPARTMENT FOR INFO.



POPLAR ▪ S4S

PLAIN SAWN ▪ FAS ▪ SURFACED FOUR SIDES

1 X 6	180-070-010
1 X 8	180-070-021
1 X 12	180-070-039



Valencia
Lumber and Panel

15809 STRATHERN STREET • VAN NUYS CA • 91406

 818-786-5800

 SALES@VALENCIALUMBER.COM

 WWW.VALENCIALUMBER.COM



HARDWOODS



SAPELE

QUARTER SAWN ▪ FAS

4/4 ROUGH 183-000-000

4/4 S2S & SL1E 183-000-010

8/4 ROUGH 183-040-000

8/4 S2S & SL1E 183-040-010



TEAK

PLAIN SAWN ▪ BURMESE ▪ FEQ

4/4 ROUGH 187-000-000

4/4 S2S & SL1E 187-000-010

4/4 ROUGH SHORTS 187-003-000

4/4 S2S & SL1E SHORTS 187-003-010

5/4 ROUGH 187-005-000

5/4 S2S & SL1E 187-005-010

6/4 ROUGH 187-010-000

8/4 ROUGH 187-020-000

8/4 S2S & SL1E 187-020-010

12/4 ROUGH 187-030-000

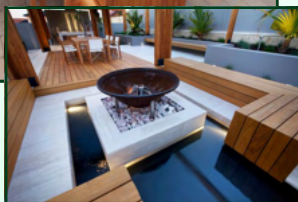

PRO-TIP:
TITEBOND III ULTIMATE WOOD GLUE IS AN EXCELLENT CHOICE FOR BONDING TEAK AND CAN BE FOUND ON PAGE 53.

FUN FACT:
LIGNIN IS WHAT MAKES WOOD HARD.
SOFTWOODS HAVE LESS OF IT,
HARDWOODS HAVE MORE OF IT.



Valencia
Lumber and Panel

15809 STRATHERN STREET • VAN NUYS CA • 91406

818-786-5800

SALES@VALENCIALUMBER.COM

WWW.VALENCIALUMBER.COM



HARDWOODS



PLAIN SAWN



WALNUT

PLAIN SAWN ▪ PRIME FAS

4/4 ROUGH 189-010-000

4/4 S2S & SL1E 189-010-010

5/4 ROUGH 189-050-000

5/4 S2S & SL1E 189-050-010

6/4 ROUGH 189-060-000

6/4 S2S & SL1E 189-060-010

8/4 ROUGH 189-070-000

8/4 S2S & SL1E 189-070-010

10/4 ROUGH 189-080-000

10/4 S2S & SL1E 189-080-010

12/4 ROUGH 189-090-000

12/4 S2S & SL1E 189-090-010

PLAIN SAWN ▪ #1 COMMON

4/4 ROUGH 189-000-000

4/4 S2S & SL1E 189-000-010

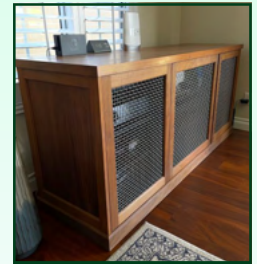

WIDE STOCK ALSO AVAILABLE.
PLEASE CONTACT OUR SALES DEPARTMENT FOR INFO.

LIVE EDGE WALNUT

1 3/4" SURFACED ▪ UP TO 12' LENGTHS 189-300-010

CASTING RESINS AND PIGMENTS ON PAGES 71 & 72



Valencia
Lumber and Panel

15809 STRATHERN STREET • VAN NUYS CA • 91406

818-786-5800

SALES@VALENCIALUMBER.COM

WWW.VALENCIALUMBER.COM



HARDWOODS



QUARTER SAWN

WALNUT

QUARTER SAWN ▪ FAS

4/4 ROUGH 189-100-000

4/4 S2S & SL1E 189-100-010

6/4 S2S & SL1E 189-140-010

8/4 ROUGH 189-150-000

8/4 S2S & SL1E 189-150-010



WENGE

QUARTER SAWN ▪ FAS

4/4 ROUGH 195-000-000

4/4 S2S & SL1E 195-000-010



ZEBRA

QUARTER SAWN ▪ FAS

4/4 ROUGH 197-000-000

4/4 S2S & SL1E 197-000-010



Valencia
Lumber and Panel

15809 STRATHERN STREET • VAN NUYS CA • 91406

☎ 818-786-5800

✉ SALES@VALENCIALUMBER.COM

🌐 WWW.VALENCIALUMBER.COM



HARDWOODS

A PRIMER

VALENCIA LUMBER & PANEL SELLS LUMBER IN THREE DIFFERENT UNITS OF MEASURE: BY THE BOARD FOOT, BY THE LINEAR FOOT, OR BY THE PIECE. MOST, BUT NOT ALL, HARDWOODS ARE SOLD BY BOARD FOOT. MOST, BUT NOT ALL, SOFTWOODS ARE SOLD BY LINEAL FOOT. TYPICALLY, IT'S SOLD BY BOARD FOOT IF IT'S IN THE ROUGH OR SURFACED AND STRAIGHT LINED ON ONE EDGE (S2S & SL1E). TYPICALLY, IT'S SOLD BY THE LINEAR FOOT IF IT'S SURFACED FOUR SIDES (S4S) OR DETAILED LIKE A TONGUE AND GROOVE (T&G). TYPICALLY, IT'S SOLD BY THE PIECE IF IT'S A LIVE EDGE SLAB, HOBBY LENGTH, OR SOMETHING SPECIAL AND UNIQUE.

SO, WHAT IS A BOARD FOOT?

A *BOARD FOOT* IS A UNIT OF MEASURE FOR THE VOLUME OF LUMBER. BASICALLY, IT IS 144 CUBIC INCHES OF LUMBER.

SO, ONE *BOARD FOOT* IS 1" X 12" X 12" IN THE ROUGH. OR 144 CUBIC INCHES.

THE SAME 12" X 12" IN 5/4 (1 1/4" ROUGH) WOULD BE 1.25 BF (180 CUBIC INCHES 144 X 1.25).

THE SAME 12" X 12" IN 8/4 (2" ROUGH) WOULD BE 2 BF (288 CUBIC INCHES 144 X 2).

IT'S ALL ABOUT THE VOLUME OF THE LUMBER.

NOMINAL THICKNESSES OF HARDWOOD LUMBER ARE MEASURED IN QUARTERS OF AN INCH. FOR EXAMPLE, 4/4 IS PRONOUNCED *FOUR QUARTER* FOR FOUR QUARTERS OF AN INCH; 5/4 IS PRONOUNCED *FIVE QUARTER* FOR FIVE QUARTERS OF AN INCH, AND SO ON. THEREFORE, 4/4 IS 1" IN THE ROUGH; 5/4 IS 1-1/4" IN THE ROUGH; 8/4 IS 2" IN THE ROUGH, AND SO ON. TYPICALLY, SURFACED HARDWOOD IS APPROXIMATELY 1/4" LESS IN FINISHED THICKNESS - MEANING 4/4 SURFACED IS APPROXIMATELY 3/4" THICK AND 8/4 SURFACED IS APPROXIMATELY 1-3/4" THICK.

DON'T CONFUSE *BOARD FEET* WITH *LINEAR FEET* OR *SQUARE FEET*, OR YOU WILL BE - CONFUSED.

BOARD FEET AND *SQUARE FEET* ARE ONLY THE SAME UNIT OF MEASURE WHEN IT'S 4/4 LUMBER.

HOW TO CALCULATE BOARD FOOTAGE (BF):

THICKNESS IN DECIMAL QUARTERS X WIDTH IN INCHES X LENGTH IN FEET ÷ 12 = BF.

FOR EXAMPLE, A BOARD

4/4 X 6" X 8' WOULD CALCULATE AS 1 X 6 X 8 ÷ 12 = 4 BF.

5/4 X 6" X 8' WOULD CALCULATE AS 1.25 X 6 X 8 ÷ 12 = 5 BF.

6/4 X 6" X 8' WOULD CALCULATE AS 1.5 X 6 X 8 ÷ 12 = 6 BF.

AND IF THE BOARD IS SURFACED & STRAIGHT LINED (S2S & SL1E), ADD APPROXIMATELY 12% FOR LOSS IN STRAIGHT LINE RIPPING. THAT'S BECAUSE WHEN 1000 BF IN THE ROUGH GOES TO MILL FOR SURFACE AND STRAIGHT LINING, ABOUT 875 BF COMES BACK. IT'S LIKE CHOOSING A 3 LB ROAST AT YOUR BUTCHER SHOP AND THEN HAVING HIM TRIM IT FOR YOU. YOU LEAVE WITH 2.4 LBS BUT YOU'RE STILL GOING TO PAY FOR 3 LBS.

WHICH BRINGS US TO RANDOM WIDTH.

HERE AT VALENCIA LUMBER AND PANEL, WE USE THE STANDARDS OF THE NHLA (NATIONAL HARDWOOD LUMBER ASSOCIATION) WHEN TALLYING LUMBER. UNDER THAT STANDARD, WE USE A "TALLY STICK", WHICH CALCULATES BOARD FEET USING THE THICKNESS, LENGTH, AND *AVERAGE WIDTH* OF THE BOARD PLUS 12% IF S2S & SL1E. IF YOU LOOK AT OUR HARDWOOD LUMBER, YOU WILL NOTICE THAT, UNLIKE HOME-CENTER LUMBER, THE BOARDS HAVE NOT BEEN RIPPED TO PRECISE, UNIFORM WIDTHS. YOU GET TO RIP THE WIDTHS YOURSELF. IF YOU ARE A PROFESSIONAL WOODWORKER, YOU ALREADY KNOW THIS. A BOARD MIGHT BE "SIX INCHES WIDE", BUT FROM END-TO-END, IT WILL VARY IN WIDTH. THE *AVERAGE WIDTH* WILL BE 6".

ABBREVIATIONS

BF = BOARD FOOT ▪ LF = LINEAR FOOT ▪ SF = SQUARE FOOT ▪ S2S = SURFACED 2 SIDES ▪ S4S = SURFACED 4 SIDES

SL1E = STRAIGHT LINE RIPPED 1 EDGE ▪ E2E = EASED 2 EDGES ▪ FAS = FIRSTS & SECONDS GRADE

FEQ = FIRST EUROPEAN QUALITY GRADE ▪ AA = A GRADE BOTH FACES ▪ A1 = A GRADE FACE/1 BACK ▪ APP = APPEARANCE GRADE

HT = HEAT TREATED ▪ DPO = DIMENSIONAL PULLED-OUT ▪ KD = KILN DRIED ▪ AD = AIR DRIED



Valencia
Lumber and Panel

15809 STRATHERN STREET • VAN NUYS CA • 91406



818-786-5800



SALES@VALENCIALUMBER.COM



WWW.VALENCIALUMBER.COM



HARDWOODS

HOW A LOG IS SAWN...

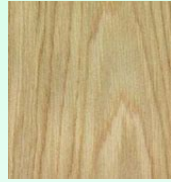

Plain Sawn

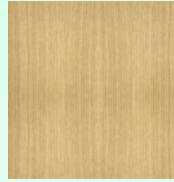

Rift Sawn



Quarter Sawn

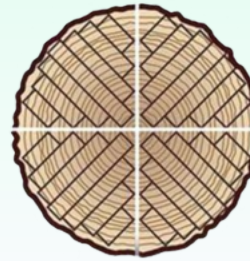
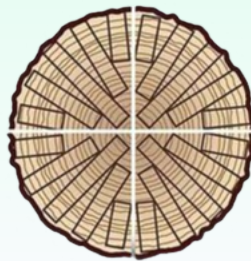

4/4 BOARD FOOT CHART IN THE ROUGH (DOUBLE FOR 8/4)

WIDTH IN INCHES

	1	2	3	4	5	6	7	8	9	10	11	12	13	14	15	16
1	.1	.2	.3	.3	.4	.5	.6	.7	.8	.8	.9	1.0	1.1	1.2	1.3	1.3
2	.2	.3	.5	.7	.7	1.0	1.2	1.3	1.5	1.7	1.8	2.0	2.2	2.3	2.5	2.7
3	.3	.5	.8	1.0	1.3	1.5	1.8	2.0	2.3	2.5	2.8	3.0	3.3	3.5	3.8	4.0
4	.3	.7	1.0	1.3	1.7	2.0	2.3	2.7	3.0	3.3	3.7	4.0	4.3	4.7	5.0	5.3
5	.4	.8	1.3	1.7	2.1	2.5	2.9	3.3	3.8	4.2	4.6	5.0	5.4	5.8	6.3	6.7
6	.5	1.0	1.5	2.0	2.5	3.0	3.5	4.0	4.5	5.0	5.5	6.0	6.5	7.0	7.5	8.0
7	.6	1.2	1.8	2.3	2.9	3.5	4.1	4.7	5.3	5.8	6.4	7.0	7.6	8.2	8.8	9.3
8	.7	1.3	2.0	2.7	3.3	4.0	4.7	5.3	6.0	6.7	7.3	8.0	8.7	9.3	10.0	10.7
9	.8	1.5	2.3	3.0	3.8	4.5	5.3	6.0	6.8	7.5	8.3	9.0	9.8	10.5	11.3	12.0
10	.8	1.7	2.5	3.3	4.2	5.0	5.8	6.7	7.5	8.3	9.2	10.0	10.8	11.7	12.5	13.3
11	.9	1.8	2.8	3.7	4.6	5.5	6.4	7.3	8.3	9.2	10.1	11.0	11.9	12.8	13.8	14.7
12	1.0	2.0	3.0	4.0	5.0	6.0	7.0	8.0	9.0	10.0	11.0	12.0	13.0	14.0	15.0	16.0
13	1.1	2.2	3.3	4.3	5.4	6.5	7.6	8.7	9.8	10.8	11.9	13.0	14.1	15.2	16.3	17.3
14	1.2	2.3	3.5	4.7	5.8	7.0	8.2	9.3	10.5	11.7	12.8	14.0	15.2	16.3	17.5	18.7
15	1.3	2.5	3.8	5.0	6.3	7.5	8.8	10.0	11.3	12.5	13.8	15.0	16.3	17.5	18.8	20.0
16	1.3	2.7	4.0	5.3	6.7	8.0	9.3	10.7	12.0	13.3	14.7	16.0	17.3	18.7	20.0	21.3

LENGTH IN FEET



Valencia
Lumber and Panel

15809 STRATHERN STREET • VAN NUYS CA • 91406



818-786-5800



SALES@VALENCIALUMBER.COM



WWW.VALENCIALUMBER.COM



HARDWOODS

5/4 BOARD FOOT CHART IN THE ROUGH (DOUBLE FOR 10/4)
WIDTH IN INCHES

	1	2	3	4	5	6	7	8	9	10	11	12	13	14	15	16
1	.1	.2	.3	.3	.5	.6	.7	.8	1.0	1.0	1.1	1.2	1.3	1.4	1.5	1.6
2	.2	.4	.6	.8	.8	1.2	1.5	1.6	1.8	2.1	2.3	2.5	2.7	2.9	3.1	3.3
3	.3	.6	1.0	1.2	1.6	1.8	2.2	2.5	2.8	3.1	3.5	3.7	4.1	4.3	4.7	5.2
4	.3	.8	1.2	1.6	2.1	2.5	2.8	3.3	3.7	4.1	4.6	5.0	5.3	5.8	6.2	6.6
5	.5	.8	1.6	2.1	2.6	3.1	3.6	4.1	4.7	5.2	5.7	6.2	6.7	7.2	7.8	8.3
6	.6	1.2	1.8	2.5	2.5	3.7	4.3	5.0	5.6	6.2	6.8	7.5	8.1	8.7	9.3	10.0
7	.7	1.5	2.2	2.8	2.9	4.3	5.1	5.8	6.6	7.2	8.0	8.7	9.5	10.2	11.0	11.6
8	.8	1.6	2.5	3.3	3.3	5.0	5.8	6.6	7.5	8.3	9.1	10.0	10.8	11.6	12.5	13.3
9	1.0	1.8	2.8	3.7	3.8	5.6	6.6	7.5	8.5	9.3	10.3	11.2	12.2	13.1	14.1	15.0
10	1.0	2.1	3.1	4.1	4.2	6.2	7.2	8.3	9.3	10.7	11.5	12.5	13.5	14.6	15.6	16.6
11	1.1	2.3	3.5	4.6	4.6	6.8	8.0	9.1	10.3	11.5	12.6	13.7	14.8	16.0	17.2	18.3
12	1.2	2.5	3.7	5.0	5.0	7.5	8.7	10.0	11.2	12.5	13.7	15.0	16.2	17.5	18.7	20.0
13	1.3	2.7	4.1	5.3	5.4	8.1	9.5	10.8	12.2	13.5	14.8	16.2	17.6	19.0	20.3	21.6
14	1.4	2.9	4.3	5.8	5.8	8.7	10.2	11.6	13.1	14.6	16.0	17.5	19.0	20.4	21.8	23.3
15	1.5	3.1	4.7	6.2	6.3	9.3	11.0	12.5	14.1	15.6	17.2	18.7	20.3	21.8	23.5	25.0
16	1.6	3.3	5.2	6.6	6.7	10.0	11.6	13.3	15.0	16.6	18.3	20.0	21.6	23.3	25.0	26.6

LENGTH IN FEET

6/4 BOARD FOOT CHART IN THE ROUGH (DOUBLE FOR 12/4)
WIDTH IN INCHES

	1	2	3	4	5	6	7	8	9	10	11	12	13	14	15	16
1	.1	.3	.4	.5	.6	.7	.9	1.0	1.2	1.2	1.3	1.5	1.6	1.8	1.9	2.0
2	.3	.4	.7	1	1.2	1.5	1.8	2.0	2.2	2.5	2.7	3.0	3.3	3.4	3.7	4.0
3	.4	.7	1.2	1.5	1.9	2.2	2.7	3.0	3.4	3.7	4.2	4.5	4.9	5.2	5.7	6.0
4	.5	1	1.5	2	2.5	3	3.5	4.0	4.5	5.0	5.5	6.0	6.5	7.0	7.5	8.0
5	.6	1.2	1.9	2.5	3.1	3.7	4.3	5.0	5.7	6.3	6.9	7.5	8.1	8.7	9.4	10.0
6	.7	1.5	2.2	3	3.7	4.5	5.2	6.0	6.7	7.5	8.2	9.0	9.7	10.5	11.2	12.0
7	.9	1.8	2.7	3.5	4.3	5.2	6.1	7.0	7.8	8.7	9.6	10.5	11.4	12.3	13.2	14.0
8	1.0	2.0	3.0	4.0	5.0	6.0	7.0	8.0	9.0	10.0	11.0	12.0	13.0	14.0	15.0	16.0
9	1.2	2.2	3.4	4.5	5.7	6.7	7.8	9.0	10.1	11.2	12.4	13.5	14.7	15.7	16.8	18.0
10	1.2	2.5	3.7	5.0	6.3	7.5	8.7	10.0	11.2	12.4	13.8	15.0	16.2	17.5	18.7	20.0
11	1.3	2.7	4.2	5.5	6.9	8.2	9.6	11.0	12.4	13.8	15.1	16.5	17.8	19.2	20.7	22.0
12	1.5	3.0	4.5	6.0	7.5	9.0	10.5	12.0	13.5	15.0	16.5	18.0	19.5	21.0	22.5	24.0
13	1.6	3.3	4.9	6.5	8.1	9.7	11.4	13.0	14.7	16.2	17.8	19.5	21.1	22.8	24.4	26.0
14	1.8	3.4	5.2	7.0	8.7	10.5	12.3	14.0	15.7	17.5	19.2	21.0	22.8	24.4	26.2	28.0
15	1.9	3.7	5.7	7.5	9.4	11.2	13.2	15.0	16.8	18.7	20.7	22.5	24.4	26.2	28.2	30.0
16	2.0	4.0	6.0	8.0	10.0	12.0	14.0	16.0	18.0	20.0	22.0	24.0	26.0	28.0	30.0	32.0

LENGTH IN FEET



Valencia
Lumber and Panel

15809 STRATHERN STREET • VAN NUYS CA • 91406



818-786-5800



SALES@VALENCIALUMBER.COM



WWW.VALENCIALUMBER.COM



SOFTWOODS

WESTERN RED CEDAR



SURFACED FOUR SIDES

EASED FOUR EDGES • CLEAR VERTICAL GRAIN • KILN DRIED

- 1 x 6 122-020-030
- 1 x 8 122-020-323
- 1 x 12 122-021-080
- 2 x 2 122-021-300

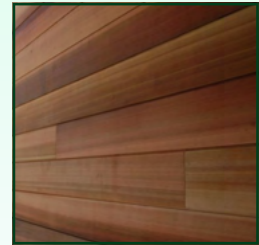

CLEAR VERTICAL GRAIN

ROUGH

CLEAR VERTICAL GRAIN • KILN DRIED

- 1 x 6 122-000-020
- 1 x 8 122-000-030
- 1 x 10 122-000-040
- 1 x 12 122-000-050
- 7/4 x 4 122-000-110
- 7/4 x 6 122-000-120
- 7/4 x 8 122-000-130
- 7/4 x 10 122-000-140
- 7/4 x 12 122-000-150
- 2 x 4 122-000-160
- 2 x 6 122-000-170
- 2 x 8 122-000-180
- 2 x 10 122-000-190
- 2 x 12 122-000-200

—TONGUE & GROOVE PROFILES—

CLEAR VERTICAL GRAIN • KILN DRIED

1x6 PATTERN 633

FLUSH/SQUARE EDGE • SURFACED BOTH SIDES
122-017-000

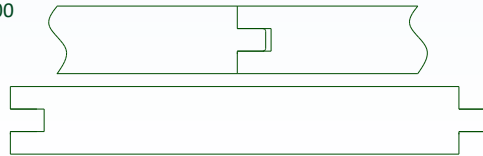

1x6 PATTERN 711

V-GROOVE • SURFACED ONE SIDE / ROUGH OTHER
122-021-429

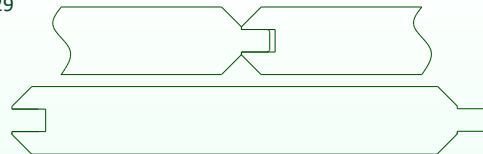

1x6 PATTERN REV

NICKEL GAP ONE SIDE / V-GROOVE OTHER • SURFACED BOTH SIDES
122-019-005

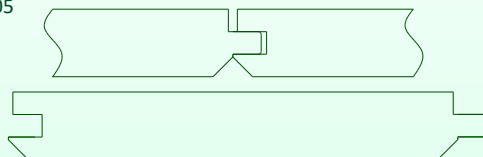

CYPRESS



TONGUE & GROOVE

SELECT & BETTER

1x6 PATTERN REV

117-000-015



Valencia
Lumber and Panel

15809 STRATHERN STREET • VAN NUYS CA • 91406



818-786-5800



SALES@VALENCIALUMBER.COM



WWW.VALENCIALUMBER.COM



SOFTWOODS



WESTERN RED CEDAR

SURFACED ONE SIDE & EASED TWO EDGES
SOUND TIGHT KNOTS • KILN DRIED

1 x 6 122-022-335

SOUND TIGHT KNOTS (STK)

—TONGUE & GROOVE—

WESTERN RED CEDAR • SOUND TIGHT KNOTS
SURFACED ONE SIDE / ROUGH OTHER SIDE

1 x 6 T&G PATTERN 711 122-021-429

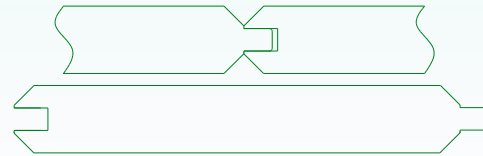

ALASKAN YELLOW CEDAR



CLEAR VERTICAL GRAIN • KILN DRIED

2 x 6 ROUGH 118-000-005

2 x 6 S2S & SL1E 118-000-010

2 x 8 ROUGH 118-000-020



FUN FACT:

*“SEQUOIA” IS THE SHORTEST WORD IN THE
ENGLISH LANGUAGE USING ALL THE VOWELS.*



Valencia
Lumber and Panel

15809 STRATHERN STREET • VAN NUYS CA • 91406

☎ 818-786-5800

✉ SALES@VALENCIALUMBER.COM

🌐 WWW.VALENCIALUMBER.COM



SOFTWOODS



85/15 VG EXPORT GRADE
TIGHTER GROWTH RING



VG DOUGLAS FIR

85/15 CLEAR VG EXPORT GRADE ROUGH FULL SAWN VERTICAL GRAIN DOUGLAS FIR

1 x 4	125-000-010	2 x 4	125-000-130
1 x 5	125-000-020	2 x 5	125-000-140
1 x 6	125-000-030	2 x 6	125-000-150
1 x 8	125-000-040	2 x 8	125-000-160
1 x 10	125-000-050	2 x 10	125-000-170
1 x 12	125-000-060	2 x 12	125-000-180

DOUGLAS FIR, FOUND GROWING IN THE PACIFIC NORTHWEST OF THE UNITED STATES AND CANADA, IS THE MOST ABUNDANT SPECIES IN THE REGION. DOUGLAS FIR CAN BE FOUND AROUND WORLD AS BEAMS, SOFFIT, SIDING, CLADDING, AND MORE. VERTICAL GRAIN 85/15 DOUG FIR IS A QUARTER SAWN CUT, WITH A HIGH DENSITY OF GROWTH RINGS, UP TO THIRTY PER INCH. THE 85/15 IS A PREMIUM GRADING MEASURE, MEANING 85% OF THE BOARD IS CLEAR #2, AND 15% OF THE BOARD IS CLEAR #3.

THE GRAIN TIGHTNESS OF 85/15 IS WHAT'S TRULY DESIRABLE ABOUT THIS GRADE OF DOUGLAS FIR; BOASTING A GRAIN COUNT OF 12-20+ PER INCH.



VG DOUGLAS FIR

CLEAR VERTICAL GRAIN (CVG) SURFACED FOUR SIDES & EASED FOUR EDGES

1 x 6	125-005-615
1 x 8	125-006-000
1 x 12	125-006-300
2 x 6	125-007-711



CVG
LOOSER GROWTH RING



Valencia
Lumber and Panel

15809 STRATHERN STREET • VAN NUYS CA • 91406



818-786-5800



SALES@VALENCIALUMBER.COM



WWW.VALENCIALUMBER.COM



SOFTWOODS



85/15 VERTICAL GRAIN
TIGHT GROWTH PATTERN

HEMLOCK

85/15 CLEAR VERTICAL GRAIN

1 x 6 ROUGH	125-009-000
1 x 6 S2S & SL1E	125-009-010
1 x 8 ROUGH	125-009-030
7/4 x 6 ROUGH	125-009-150
2 x 6 ROUGH	125-009-250



—THERMLOCK—

THERMALLY MODIFIED VG HEMLOCK
1 x 6 S4S & E4E 125-009-293

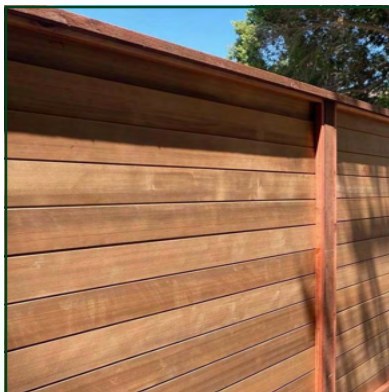

—TONGUE & GROOVE—

CLEAR VERTICAL GRAIN HEMLOCK
T&G REVERSIBLE PATTERN
NICKEL GAP/V-GROOVE
1 x 6 125-101-000
1 x 4 125-040-010

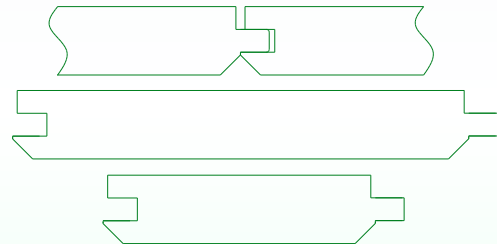

WHEN SOFTWOODS LIKE HEMLOCK ARE THERMALLY MODIFIED, IT GENERALLY MAKES THE WOOD HARDER, MORE ROT RESISTANT, AND MORE STABLE THAN THE ORIGINAL WOOD.

THE UNIQUE PROCESS THAT THERMALLY MODIFIES HEMLOCK USES A VACUUM KILN. IT'S A GAME CHANGER. THE VACUUM KILN RAISES THE PRESSURE, SO LESS HEAT IS REQUIRED TO 'COOK' THE SUGARS OUT OF THE WOOD.

THERMALLY MODIFIED HEMLOCK IS STRONGER THAN STANDARD HEMLOCK. SCIENTIFIC TESTING CONFIRMS THAT THERMLOCK IS 107% MORE DIFFICULT TO BREAK THAN KILN DRIED HEMLOCK.



Valencia
Lumber and Panel

15809 STRATHERN STREET • VAN NUYS CA • 91406

 818-786-5800

 SALES@VALENCIALUMBER.COM

 WWW.VALENCIALUMBER.COM



SOFTWOODS



PINE

1 X 3 X 16' SPF PREMIUM 10 PIECE BUNDLE 178-750-000

1 X 12 X 16' S4S #2 COMMON SUGAR PINE 177-500-129

2 X 12 X 16' S4S #2 COMMON SUGAR PINE 177-500-448

8/4 ROUGH MLDG & BTR SUGAR PINE KD 177-350-000



—TONGUE & GROOVE—

T&G SUGAR PINE WP4

SOUND TIGHT KNOTS

1 X 6 178-775-000

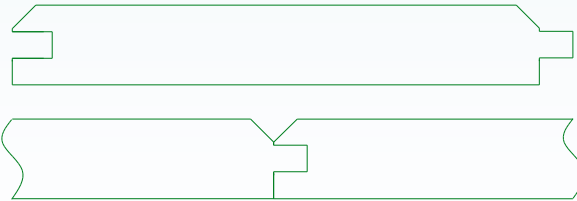

FUN FACT:
TURPENTINE IS A DISTILLED PRODUCT FROM THE RESIN OF PINE TREES. THE RESIN IS HARVESTED IN VERY MUCH THE SAME WAY AS THE SYRUP FROM MAPLE TREES.



Valencia
Lumber and Panel

15809 STRATHERN STREET • VAN NUYS CA • 91406

818-786-5800

SALES@VALENCIALUMBER.COM

WWW.VALENCIALUMBER.COM



SOFTWOODS



REDWOOD

CLEAR AYE ▪ SURFACE 4 SIDES AND EASED 4 EDGES

1 x 4	165-000-003	2 x 2	166-050-136
1 x 6	166-000-000	2 x 4	166-050-295
1 x 8	166-025-772	2 x 6	166-050-405
1 x 12	166-026-100	2 x 8	166-050-809
		2 X 12	166-051-063

B GRADE ▪ SURFACED 4 SIDES AND EASED 4 EDGES

4 x 4 166-051-401

OTHER GRADES AND SIZES AVAILABLE.
PLEASE CONTACT OUR SALES DEPARTMENT FOR MORE INFO.



—TONGUE & GROOVE—

PATTERN 711R

SURFACED ONE SIDE, ROUGH THE OTHER SIDE
1 x 6 KILN DRIED 166-025-002

PATTERN 28

SURFACED 2 SIDES
1 x 6 AIR DRIED (ALL 6' LENGTHS) 166-025-333

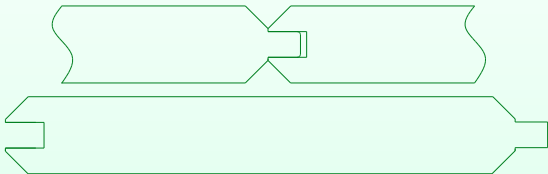

Valencia
Lumber and Panel

15809 STRATHERN STREET • VAN NUYS CA • 91406

☎ 818-786-5800

✉ SALES@VALENCIALUMBER.COM

🌐 WWW.VALENCIALUMBER.COM



SOFTWOODS



INDUSTRIALS

2 x 4 x 16' WHITE FIR APP KD HT	125-031-161
4 x 4 x 12' HEM/FIR S4S UTILITY & BETTER HT	125-032-156
4 x 4 x 16' HEM/FIR S4S UTILITY & BETTER HT	125-032-208
2 x 12 DOUG FIR S4S DPO KD	125-030-042

OTHER DIMENSIONS OF INDUSTRIAL & UTILITY GRADES AVAILABLE.
PLEASE CONTACT OUR SALES DEPARTMENT FOR MORE INFO.



Valencia
Lumber and Panel

15809 STRATHERN STREET • VAN NUYS CA • 91406

☎ 818-786-5800

✉ SALES@VALENCIALUMBER.COM

🌐 WWW.VALENCIALUMBER.COM



RECLAIMED



ANTIQUE BROWN BARNWOOD

1 X RANDOM WIDTH & LENGTHS 311-054-000



ANTIQUE GRAY BARNWOOD

1 X RANDOM WIDTH & LENGTHS 311-053-000



ANTIQUE WEATHERED REDWOOD

1 X RANDOM WIDTH & LENGTHS 311-055-200



Valencia
Lumber and Panel

15809 STRATHERN STREET • VAN NUYS CA • 91406

*FUN FACT:
THE WORLD'S BLACKEST WOOD IS EBONY,
THE WORLD'S WHITEST IS HOLLY.*

 818-786-5800

 SALES@VALENCIALUMBER.COM

 WWW.VALENCIALUMBER.COM



RECLAIMED



HARBOR FIR

1 x RANDOM WIDTH & LENGTHS 311-051-000



MUSHROOM WOOD

1 x RANDOM WIDTH & LENGTHS 311-055-000

1 x 6 RANDOM LENGTHS 311-055-018



NATURE AGED GRAY

1 x RANDOM WIDTH & LENGTHS 311-050-000



Valencia
Lumber and Panel

15809 STRATHERN STREET • VAN NUYS CA • 91406



818-786-5800



SALES@VALENCIALUMBER.COM



WWW.VALENCIALUMBER.COM



RECLAIMED



WEATHERED OAK

1 X RANDOM WIDTH & LENGTHS 311-054-801



BOXED THINS

BOXED THINS COME 30SF PER BOX
5/16" X 5" X 12"- 48" LENGTHS,
AVERAGING 45" LENGTHS.

- GRAY BLEND 311-056-212
- BROWN BLEND 311-056-224
- BROWN/GRAY BLEND 311-056-236
- MIXED HARDWOOD BRIGHT 311-056-248
- ANTIQUE WEATHERED REDWOOD 311-056-260



GRAY BLEND



BROWN BLEND



BROWN/GRAY BLEND

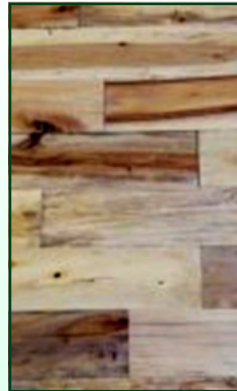

MIXED
HARDWOOD
BRIGHT

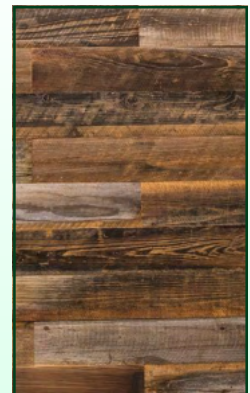

ANTIQUE
WEATHERED
REDWOOD



Valencia
Lumber and Panel

15809 STRATHERN STREET • VAN NUYS CA • 91406

818-786-5800

SALES@VALENCIALUMBER.COM

WWW.VALENCIALUMBER.COM



LIVE EDGE



FRENCH ASH BURL



DOUGLAS FIR

OUR INVENTORY OF LIVE EDGE IS CHANGING CONSTANTLY. WE ARE ALWAYS BRINGING IN SOMETHING NEW AND EXCITING. LIVE EDGE IS UNIQUE AND HAS ITS OWN PERSONALITY, SO IT'S WORTH A VISIT TO SEE WHAT WE HAVE TO OFFER. PLEASE DON'T HESITATE TO CONTACT OUR SALES DEPARTMENT WITH ANY QUESTIONS OR REQUESTS.



PADAUK



WALNUT



Valencia
Lumber and Panel

15809 STRATHERN STREET • VAN NUYS CA • 91406



818-786-5800



SALES@VALENCIALUMBER.COM



WWW.VALENCIALUMBER.COM



PANELS & VENEERS

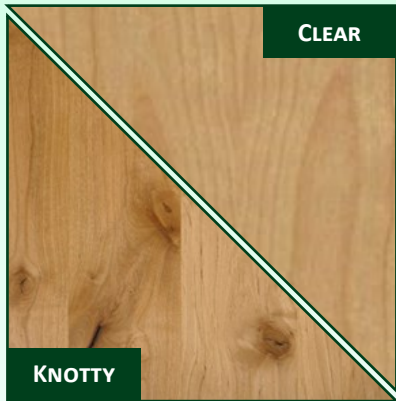

ALDER

1/4" 4x8	MDF CORE A4 PS BM	220-501-500
5.2MM 4x8	MDF CORE AB PS BM PREMIUM	220-502-000
1/2" 4x8	MDF CORE AB PS BM PREMIUM	220-503-250
3/4" 4x8	MDF CORE AB PS BM	220-506-500
3/4" 4x10	MDF CORE AB PS BM	220-507-250
5.4MM 4x8	MDF CORE AA PS BM KNOTTY PREMIUM	220-501-750
3/4" 4x8	MDF CORE AA PS BM KNOTTY PREMIUM	220-506-000
1/2" 4x8	VENEER CORE BB PS BM	220-502-600
3/4" 4x8	VENEER CORE SHOP PS BM	220-505-200
3/4" 4x8	VENEER CORE BB PS BM	220-505-225
3/4" 4x8	COMBI-CORE SHOP PS BM	220-505-250
3/4" 4x8	COMBI-CORE AB PS BM PREMIUM	220-505-500

ADHESIVES ON PAGES 53 - 54
EDGE-BANDING ON PAGES 57 - 62
VENEER & LAMINATE SLITTER ON PAGE 97

VENEERS

2x8 PSA PS	830-011-100
4x8 10MIL PS	830-011-150
4x10 10MIL PS	830-011-160
4x8 2PLY PS	830-011-200



ASH

PANELS

1/4" 4x8	MDF CORE A4 PS BM	220-700-500
3/4" 4x8	MDF CORE A1 PS BM SM&N	220-701-600
3/4" 4x8	MDF CORE A1 QUARTER SAWN SM&N	220-702-500
3/4" 4x8	COMBI-CORE A1 PS BM SM&N	220-701-500

VENEERS

4x8 10MIL PS	830-011-216
--------------	-------------

A1, A4, AB, ETC. = GRADE
PS = PLAIN SLICE
BM = BOOK MATCHED
SM = SLIP MATCHED
WPF = WHOLE PIECE FACE (IDEAL FOR PAINTING)
SM&N = SEQUENCE MATCHED & NUMBERED
PSA = PRESSURE SENSITIVE ADHESIVE
10MIL = 10MIL PAPER BACKED
2PLY = 20MIL CROSSBAND WOOD BACK



15809 STRATHERN STREET • VAN NUYS CA • 91406

818-786-5800

SALES@VALENCIALUMBER.COM

WWW.VALENCIALUMBER.COM



PANELS & VENEERS



BEECH

1/4" 4x8 MDF CORE A4 PS BM 221-001-500

3/4" 4x8 MDF CORE A1 PS BM 221-004-000

VENEERS

4x8 10MIL PS 830-011-240

ALL BEECH PANELS AND VENEERS ARE STEAMED FOR UNIFORM COLOR



BIRCH

—NATURAL DOMESTIC UNFINISHED—

1/4" 4x8 MDF CORE C4 WPF 221-240-725

3/4" 4x8 VENEER CORE SHOP WPF 221-242-750

3/4" 4x10 VENEER CORE C2 WPF 221-243-750

1" 4x8 VENEER CORE C2 WPF 221-244-550

1/2" 4x8 VENEER CORE C2 221-241-230

3/4" 4x8 COMBI-CORE A1 WPF 221-243-250



BIRCH

—WHITE IMPORT UNFINISHED—

5.2MM 4x8 VENEER CORE C4 221-261-000

12MM 4x8 VENEER CORE C2 WPF VIET 221-261-500

12MM 4x8 VENEER CORE C2 WPF INDO 221-261-525

15MM 4x8 VENEER CORE C2 WPF VIET 221-261-600

15MM 4x8 VENEER CORE C2 WPF INDO 221-261-625

18MM 4x8 VENEER CORE C2 WPF VIET 221-261-750

18MM 4x8 VENEER CORE C2 WPF INDO 221-261-751

A1, A4, AB, ETC. = GRADE
PS = PLAIN SLICE
BM = BOOK MATCHED
SM = SLIP MATCHED
WPF = WHOLE PIECE FACE (IDEAL FOR PAINTING)
SM&N = SEQUENCE MATCHED & NUMBERED
PSA = PRESSURE SENSITIVE ADHESIVE
10MIL = 10MIL PAPER BACKED
2PLY = 20MIL CROSSBAND WOOD BACK



Valencia
Lumber and Panel

15809 STRATHERN STREET • VAN NUYS CA • 91406

818-786-5800

SALES@VALENCIALUMBER.COM

WWW.VALENCIALUMBER.COM



PANELS & VENEERS



BIRCH

—WHITE IMPORT *PREFINISHED*—

5.2MM 4x8 VENEER CORE C2 WPF FINISHED 1 SIDE	221-220-500
12MM 4x8 VENEER CORE C2 WPF FINISHED 2 SIDES VIET	221-221-000
12MM 4x8 VENEER CORE C2 WPF FINISHED 2 SIDES INDO	221-221-100
18MM 4x8 VENEER CORE C2 WPF FINISHED 1 SIDE VIET	221-222-250
18MM 4x8 VENEER CORE C2 WPF FINISHED 1 SIDE INDO	221-222-300
18MM 4x8 VENEER CORE C2 WPF FINISHED 2 SIDES VIET	221-222-500
18MM 4x8 VENEER CORE C2 WPF FINISHED 2 SIDES INDO	221-222-525
18MM 4x8 VENEER CORE C2 WPF FINISHED 2 SIDES INDO PR.	221-222-535



EURO-BIRCH

—MULTI-PLY EURO CORE *UNFINISHED*—

3MM 5x5 BB/BB	221-200-500
6MM 5x5 B/BB	221-200-775
6MM 4x8 BB/CP	221-200-800
9MM 4x8 BB/CP	221-201-050
12MM 5x5 BB/BB	221-201-750
12MM 4x8 BB/BB EXT	221-202-000
12MM 10x5 BB/CP EXT	221-202-275
15MM 4x8 BB/BB EXT	221-202-600
18MM 5x5 BB/CP	221-202-750
18MM 4x8 BB/BB EXT	221-203-250
18MM 10x5 CP/CP EXT	221-203-600
24MM 4x8 BB/CP EXT	221-203-750
24MM 10x5 CP/CP EXT	221-203-800

ADHESIVES ON PAGES 53 - 54
EDGE-BANDING ON PAGES 57 - 62
VENEER & LAMINATE SLITTER ON PAGE 97

A1, A4, AB, ETC. = GRADE
PS = PLAIN SLICE
BM = BOOK MATCHED
SM = SLIP MATCHED
WPF = WHOLE PIECE FACE (IDEAL FOR PAINTING)
SM&N = SEQUENCE MATCHED & NUMBERED
PSA = PRESSURE SENSITIVE ADHESIVE
10MIL = 10MIL PAPER BACKED
2PLY = 20MIL CROSSBAND WOOD BACK



Valencia
Lumber and Panel

15809 STRATHERN STREET • VAN NUYS CA • 91406



818-786-5800



SALES@VALENCIALUMBER.COM



WWW.VALENCIALUMBER.COM



PANELS & VENEERS



EURO-BIRCH

—MULTI-PLY EURO CORE *PREFINISHED*—

12MM 5x5 BB/BB FINISHED 2 SIDES	221-221-500
12MM 4x8 BB/BB FINISHED 2 SIDES	221-222-000
18MM 4x8 BB/BB FINISHED 2 SIDES	221-222-110
12MM x 8-3/16" x 60" DRAWER SIDE NO GROOVE	801-500-250
12MM x 11-5/8" x 60" DRAWER SIDE NO GROOVE	801-500-300



CEDAR-AROMATIC

5.2MM 4x8 MDF CORE 2 SIDED IMPORT	221-300-520
3/4" 4x8 VENEER CORE 2 SIDED	221-300-550
3/4" 4x8 COMBI-CORE 2 SIDED	221-300-600

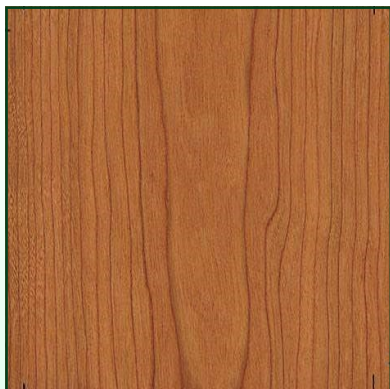

CHERRY

—PLAIN SAWN—

1/4" 4x8 MDF CORE A4	221-601-500
1/2" 4x8 MDF CORE A1	221-604-000
3/4" 4x8 MDF CORE A1 SM&N	221-606-500

VENEERS

4x8 10MIL	830-011-300
4x8 2PLY	830-011-320

A1, A4, AB, ETC. = GRADE
PS = PLAIN SLICE
BM = BOOK MATCHED
SM = SLIP MATCHED
WPF = WHOLE PIECE FACE (IDEAL FOR PAINTING)
SM&N = SEQUENCE MATCHED & NUMBERED
PSA = PRESSURE SENSITIVE ADHESIVE
10MIL = 10MIL PAPER BACKED
2PLY = 20MIL CROSSBAND WOOD BACK



Valencia
Lumber and Panel

15809 STRATHERN STREET • VAN NUYS CA • 91406

818-786-5800

SALES@VALENCIALUMBER.COM

WWW.VALENCIALUMBER.COM



PANELS & VENEERS



VG DOUG FIR

- 1/4" 4x8 MDF CORE A4 222-000-750
- 1/2" 4x8 MDF CORE A1 222-001-000
- 3/4" 4x8 MDF CORE A4 222-003-000
- 3/4" 4x10 MDF CORE A4 222-003-500

VENEERS

- 4x8 10MIL PS 830-011-337
- 4x8 2PLY PS 830-011-339



AFRICAN MAHOGANY

—PLAIN SAWN—

- 1/4" 4x8 MDF CORE A4 225-001-500
- 1/2" 4x8 MDF CORE A1 225-003-000
- 3/4" 4x8 MDF CORE A1 SM&N 225-006-000
- 3/4" 4x10 MDF CORE A1 SM&N 225-006-500
- 3/4" 4x8 COMBI-CORE A1 SM&N 225-005-000

VENEERS

- 4x8 10MIL 830-011-365
- 4x8 2PLY 830-011-368
- 4x8 10MIL QUARTER SAWN 830-011-373
- 4x8 2PLY QUARTER SAWN 830-011-377

ADHESIVES ON PAGES 53 - 54
EDGE-BANDING ON PAGES 57 - 62
VENEER & LAMINATE SLITTER ON PAGE 97

NEED A CUSTOM PANEL?
MAYBE A SYCAMORE FACE WITH A MAPLE BACK?
CUSTOM LAY-UP SERVICES AVAILABLE.
PLEASE CONTACT OUR SALES DEPARTMENT FOR INFO.



Valencia
Lumber and Panel

15809 STRATHERN STREET • VAN NUYS CA • 91406



818-786-5800



SALES@VALENCIALUMBER.COM



WWW.VALENCIALUMBER.COM



A1, A4, AB, ETC. = GRADE
PS = PLAIN SLICE
BM = BOOK MATCHED
SM = SLIP MATCHED
WPF = WHOLE PIECE FACE (IDEAL FOR PAINTING)
SM&N = SEQUENCE MATCHED & NUMBERED
PSA = PRESSURE SENSITIVE ADHESIVE
10MIL = 10MIL PAPER BACKED
2PLY = 20MIL CROSSBAND WOOD BACK

PANELS & VENEERS



MAPLE

—NATURAL DOMESTIC UNFINISHED—

3/4" 4x8	MDF CORE C2 WPF	226-002-500
1/2" 4x8	VENEER CORE SHOP	226-001-000
1/2" 4x8	VENEER CORE C2 WPF	226-001-150
1/2" 4x10	VENEER CORE C2 WPF	226-001-250
5/8" 4x8	VENEER CORE C2 WPF	226-001-400
3/4" 4x8	VENEER CORE SHOP WPF	226-001-500
3/4" 4x10	VENEER CORE C2 WPF	226-003-000
1" 4x8	VENEER CORE C2 WPF	226-004-000
1" 4x10	VENEER CORE C2 WPF	226-004-100
3/4" 4x8	COMBI-CORE C2 WPF	226-002-400

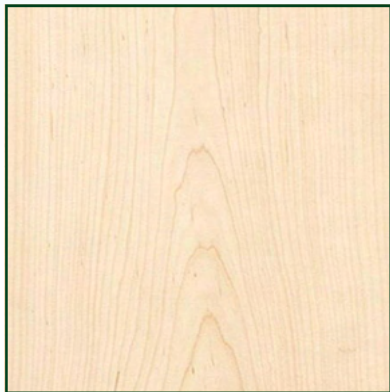

MAPLE

—WHITE DOMESTIC UNFINISHED—

5/32" 4x8	MDF CORE B4 WPF	226-100-300
1/4" 4x8	MDF CORE C4 WPF	226-101-300
1/4" 4x8	MDF CORE A4 PS	226-101-750
5.2MM 4x8	MDF CORE A1 PS	226-102-250
1/4" 4x10	MDF CORE C4 WPF	226-102-525
1/2" 4x8	MDF CORE A1 PS	226-103-500
3/4" 4x8	MDF CORE A1 PS SM&N	226-108-000
3/4" 4x10	MDF CORE A1 PS SM&N	226-108-750
1" 4x10	MDF CORE A1 PS SM&N	226-109-600
1/4" 4x8	VENEER CORE C4 WPF	226-100-600
3/8" 4x8	VENEER CORE C2 WPF	226-102-700
1/2" 4x8	VENEER CORE C2 WPF	226-102-800
3/4" 4x8	VENEER CORE C2 WPF	226-104-025
3/4" 4x8	COMBI-CORE A1 WPF	226-105-750
3/4" 4x8	COMBI-CORE A1 PS	226-106-000
3/4" 4x10	COMBI-CORE C1 WPF	226-108-500

VENEERS

2x8	PSA PS	830-011-430
4x8	10MIL PS	830-011-450
4x10	10MIL PS	830-011-460
4x8	2PLY PS	830-011-500
4x10	2PLY PS	830-011-505

A1, A4, AB, ETC. = GRADE
 PS = PLAIN SLICE
 BM = BOOK MATCHED
 SM = SLIP MATCHED
 WPF = WHOLE PIECE FACE (IDEAL FOR PAINTING)
 SM&N = SEQUENCE MATCHED & NUMBERED
 PSA = PRESSURE SENSITIVE ADHESIVE
 10MIL = 10MIL PAPER BACKED
 2PLY = 20MIL CROSSBAND WOOD BACK



Valencia
Lumber and Panel

15809 STRATHERN STREET • VAN NUYS CA • 91406



818-786-5800



SALES@VALENCIALUMBER.COM



WWW.VALENCIALUMBER.COM



PANELS & VENEERS



MAPLE

—WHITE DOMESTIC *PREFINISHED*—

1/4" 4x8	MDF CORE C4 WPF FINISHED 1 SIDE	226-301-750
1/4" 4x10	MDF CORE C4 FINISHED 1 SIDE	226-301-850
1/4" 4x8	MDF CORE C1 WPF FINISHED 2 SIDES	226-302-000
1/4" 4x8	VENEER CORE C4 FINISHED 1 SIDE	226-301-000
3/8" 4x8	VENEER CORE C2 WPF FINISHED 2 SIDES	226-302-200
1/2" 4x8	VENEER CORE VLC FINISHED 2 SIDES	226-302-750
1/2" 4x10	VENEER CORE C2 WPF FINISHED 2 SIDES	226-302-775
5/8" 4x8	VENEER CORE VLC FINISHED 2 SIDES	226-303-720
3/4" 4x8	VENEER CORE C2 WPF FINISHED 1 SIDE	226-304-220
3/4" 4x8	VENEER CORE C2 WPF FINISHED 2 SIDES	226-304-245
3/4" 4x10	VENEER CORE C2 FINISHED 2 SIDES	226-306-000
1" 4x8	VENEER CORE C2 WPF FINISHED 2 SIDES	226-304-245
3/4" 4x8	COMBI-CORE C2 WPF FINISHED 2 SIDES	226-304-950

ADHESIVES ON PAGES 53 - 54
EDGE-BANDING ON PAGES 57 - 62
VENEER & LAMINATE SLITTER ON PAGE 97

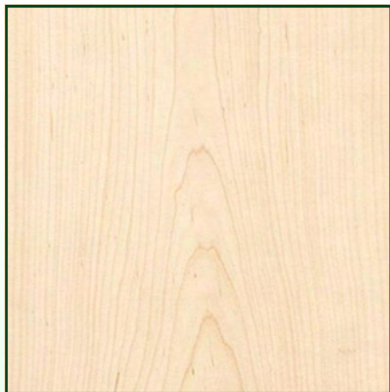

APPLE PLY

—MULTI-PLY EURO CORE WHITE MAPLE—

1/2" 4X8 C2 UNFINISHED	226-401-000
1/2" 4X8 C2 FINISHED 2 SIDES	226-402-000
3/4" 4X8 B1 UNFINISHED	226-403-000
3/4" 4X8 B1 FINISHED 2 SIDES	226-403-500

A1, A4, AB, ETC. = GRADE
PS = PLAIN SLICE
BM = BOOK MATCHED
SM = SLIP MATCHED
WPF = WHOLE PIECE FACE (IDEAL FOR PAINTING)
SM&N = SEQUENCE MATCHED & NUMBERED
PSA = PRESSURE SENSITIVE ADHESIVE
10MIL = 10MIL PAPER BACKED
2PLY = 20MIL CROSSBAND WOOD BACK



Valencia
Lumber and Panel

15809 STRATHERN STREET • VAN NUYS CA • 91406



818-786-5800



SALES@VALENCIALUMBER.COM



WWW.VALENCIALUMBER.COM



PANELS & VENEERS



PLAIN SAWN

RED OAK

—PLAIN SAWN—

2.7 _{MM}	4x8 MDF CORE 1 SIDED IMPORT	227-000-350
1/4"	4x8 MDF CORE A4 DOMESTIC	227-001-500
5.2 _{MM}	4x8 MDF CORE A1 DOMESTIC	227-001-750
3/4"	4x8 MDF CORE A1 SM&N DOMESTIC	227-004-750
1/2"	4x8 VENEER CORE C2 DOMESTIC	227-002-800
3/4"	4x8 VENEER CORE SHOP DOMESTIC	227-003-500
3/4"	4x8 VENEER CORE A1 DOMESTIC	227-003-750

VENEERS

2x8	PSA PS	830-011-580
4x8	10MIL PS	830-011-600
4x10	10MIL PS	830-011-610
4x8	2PLY PS	830-011-650



QUARTER SAWN

WHITE OAK

—QUARTER SAWN—

1/4"	4x8 MDF CORE A4	227-580-500
1/2"	4x8 MDF CORE A1	227-580-750
3/4"	4x8 MDF CORE A1	227-581-500
3/4"	4x8 COMBI-CORE A1	227-581-000

VENEERS

4x8	10MIL	830-011-755
4x8	2PLY	830-011-760

A1, A4, AB, ETC. = GRADE
 PS = PLAIN SLICE
 BM = BOOK MATCHED
 SM = SLIP MATCHED
 WPF = WHOLE PIECE FACE (IDEAL FOR PAINTING)
 SM&N = SEQUENCE MATCHED & NUMBERED
 PSA = PRESSURE SENSITIVE ADHESIVE
 10MIL = 10MIL PAPER BACKED
 2PLY = 20MIL CROSSBAND WOOD BACK



Valencia
Lumber and Panel

15809 STRATHERN STREET • VAN NUYS CA • 91406



818-786-5800



SALES@VALENCIALUMBER.COM



WWW.VALENCIALUMBER.COM



PANELS & VENEERS



PLAIN SAWN

VENEERS

4x8 10MIL STANDARD	830-011-690
4x10 10MIL STANDARD	860-011-692
4x8 2PLY STANDARD	830-011-693
4x10 2PLY STANDARD	830-011-694
4x10 2PLY PREMIUM	830-011-695

WHITE OAK

—PLAIN SAWN—

5/32" 4x8	MDF CORE A4 DOMESTIC	227-501-225
5.2MM 4x8	MDF CORE B2 IMPORT	227-501-950
1/4" 4x8	MDF CORE A4 DOMESTIC	227-502-000
1/4" 4x10	MDF CORE A4 DOMESTIC	227-502-100
5.2MM 4x8	MDF CORE A1 DOMESTIC	227-502-250
1/2" 4x8	MDF CORE A1 DOMESTIC	227-503-500
1/2" 4x10	MDF CORE A1 DOMESTIC	227-503-600
18MM 4x8	MDF CORE B2 IMPORT	227-505-950
3/4" 4x8	MDF CORE A1 SM&N DOMESTIC	227-506-000
3/4" 4x10	MDF CORE A1 SM&N DOMESTIC	227-506-500
1" 4x8	MDF CORE A1 SM&N DOMESTIC	227-506-850
1/2" 4x8	COMBI-CORE A1 DOMESTIC	227-503-000
18MM 4x8	COMBI-CORE B2 IMPORT	227-504-000
3/4" 4x8	COMBI-CORE A1 DOMESTIC	227-504-950
3/4" 4x8	COMBI-CORE A1 SM&N DOMESTIC	227-505-000

PREFINISHED

1/4" 4x8	MDF CORE A4 FINISHED 1 SIDE DOM.	226-501-130
3/4" 4x8	COMBI-CORE A1 FINISHED 2 SIDES DOM.	226-501-136



RUSTIC

WHITE OAK

—RUSTIC—

3/4" 4x8	MDF CORE PLANK MATCHED 2 SIDED	227-503-850
3/4" 4x10	MDF CORE PLANK MATCHED 2 SIDED	227-503-860

VENEERS

4x8 10MIL PS	830-011-680
---------------------	-------------

A1, A4, AB, ETC. = GRADE
 PS = PLAIN SLICE
 BM = BOOK MATCHED
 SM = SLIP MATCHED
 WPF = WHOLE PIECE FACE (IDEAL FOR PAINTING)
 SM&N = SEQUENCE MATCHED & NUMBERED
 PSA = PRESSURE SENSITIVE ADHESIVE
 10MIL = 10MIL PAPER BACKED
 2PLY = 20MIL CROSSBAND WOOD BACK



Valencia
Lumber and Panel

15809 STRATHERN STREET • VAN NUYS CA • 91406



818-786-5800



SALES@VALENCIALUMBER.COM



WWW.VALENCIALUMBER.COM



PANELS & VENEERS

WHITE OAK

— RIFT SAWN —

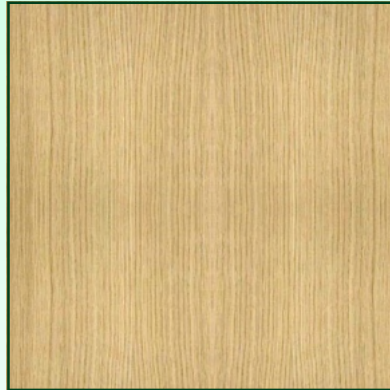

RIFT SAWN



BOOK MATCH



SLIP MATCH



PLANK MATCH

5/32" 4x8	MDF CORE B4 BM DOMESTIC	227-550-900
5.2MM 4x8	MDF CORE B2 BM IMPORT	227-550-980
1/4" 4x8	MDF CORE B4 BM DOMESTIC	227-550-990
1/4" 4x8	MDF CORE A4 BM DOMESTIC	227-551-000
1/4" 4x10	MDF CORE A4 BM DOMESTIC	227-551-250
5.2MM 4x8	MDF CORE A1 w/RIFT BACK DOMESTIC	227-551-500
1/2" 4x8	MDF CORE B1 BM DOMESTIC	227-552-490
1/2" 4x8	MDF CORE A1 w/RIFT BACK DOMESTIC	227-552-500
1/2" 4x8	MDF CORE A1 SM DOMESTIC	227-552-525
1/2" 4x10	MDF CORE A1 w/PS BACK DOMESTIC	227-552-750
18MM 4x8	MDF CORE B2 BM IMPORT	227-555-250
3/4" 4x8	MDF CORE A1 BM w/RIFT Bk DOM SM&N	227-556-000
3/4" 4x8	MDF CORE A1 BM w/RIFT Bk DOM SM&N PREM	227-556-100
3/4" 4x8	MDF CORE A1 SM w/RIFT Bk DOM SM&N	227-556-150
3/4" 4x10	MDF CORE A1 BM DOMESTIC SM&N	227-557-750
3/4" 4x10	MDF CORE A1 SM DOMESTIC SM&N	227-557-800
1" 4x10	MDF CORE A1 BM DOMESTIC SM&N	227-558-150
1/2" 4x8	COMBI-CORE B1 w/RIFT BACK DOMESTIC	227-551-850
1/2" 4x8	COMBI-CORE A1 w/RIFT BACK DOMESTIC	227-552-000
18MM 4x8	COMBI-CORE B2 BM IMPORT	227-553-975
3/4" 4x8	COMBI-CORE A1 BM w/RIFT Bk DOMESTIC	227-554-500
3/4" 4x8	COMBI-CORE A1 BM w/RIFT Bk DOM SM&N	227-554-750
3/4" 4x10	COMBI-CORE A1 BM w/PS Bk DOM SM&N	227-556-500

PREFINISHED

1/4" 4x8	MDF CORE A4 FINISHED 1 SIDE DOMESTIC	226-501-140
3/4" 4x8	COMBI-CORE A1 FINISHED 2 SIDES DOMESTIC	226-501-145

VENEERS

4x8	10MIL STANDARD	830-011-699
8x4	20MIL SHORT GRAIN	860-011-705
4x10	10MIL STANDARD	830-011-715
4x8	2PLY STANDARD	830-011-740
4x8	2PLY PREMIUM	830-011-750
4x10	2PLY PREMIUM	830-011-751

A1, A4, AB, ETC. = GRADE
 PS = PLAIN SLICE
 BM = BOOK MATCHED
 SM = SLIP MATCHED
 WPF = WHOLE PIECE FACE (IDEAL FOR PAINTING)
 SM&N = SEQUENCE MATCHED & NUMBERED
 PSA = PRESSURE SENSITIVE ADHESIVE
 10MIL = 10MIL PAPER BACKED
 2PLY = 20MIL CROSSBAND WOOD BACK



Valencia
Lumber and Panel

15809 STRATHERN STREET • VAN NUYS CA • 91406



818-786-5800



SALES@VALENCIALUMBER.COM



WWW.VALENCIALUMBER.COM



PANELS & VENEERS



KNOTTY PINE

- 1/4" 4x8 MDF CORE A4** 227-750-600
- 3/4" VENEER CORE A1** 227-751-975
- 3/4" COMBI-CORE A1** 227-752-000



SAPELE

—QUARTER SAWN—

- 1/4" 4x8 MDF CORE A4** 228-301-000
- 3/4" 4x8 MDF CORE A1 SM&N** 228-303-000
- VENEERS**
- 4x8 10MIL** 830-011-768



TEAK

- 1/4" 4x8 MDF CORE A4 PS** 228-701-000
- 3/4" 4x8 MDF CORE A1 PS SM&N** 228-704-250
- 1/4" 4x8 MDF CORE A4 QUARTER SAWN** 228-705-030
- 3/4" 4x8 MDF CORE A1 QUARTER SAWN SM&N** 228-704-250
- VENEERS**
- 4x8 10MIL PS** 830-011-774
- 4x8 2PLY PS** 830-001-775
- 4x8 10MIL QUARTER SAWN** 830-001-778

A1, A4, AB, ETC. = GRADE
 PS = PLAIN SLICE
 BM = BOOK MATCHED
 SM = SLIP MATCHED
 WPF = WHOLE PIECE FACE (IDEAL FOR PAINTING)
 SM&N = SEQUENCE MATCHED & NUMBERED
 PSA = PRESSURE SENSITIVE ADHESIVE
 10MIL = 10MIL PAPER BACKED
 2PLY = 20MIL CROSSBAND WOOD BACK



Valencia
Lumber and Panel

15809 STRATHERN STREET • VAN NUYS CA • 91406



818-786-5800



SALES@VALENCIALUMBER.COM



WWW.VALENCIALUMBER.COM



PANELS & VENEERS



PLAIN SAWN

ADHESIVES ON PAGES 53 - 54
EDGE-BANDING ON PAGES 57 - 62
VENEER & LAMINATE SLITTER ON PAGE 97

WALNUT

—PLAIN SAWN—

5/32" 4x8	MDF CORE A4 DOMESTIC	228-900-350
6MM 4x8	MDF CORE A1 IMPORT	228-900-400
1/4" 4x8	MDF CORE A4 DOMESTIC	228-900-750
1/4" 4x10	MDF CORE A4 DOMESTIC	228-901-000
5.4MM 4x8	MDF CORE A1 NSB DOMESTIC	228-901-100
1/2" 4x8	MDF CORE A1 NSB DOMESTIC	228-902-000
1/2" 4x10	MDF CORE A1 NSB DOMESTIC	228-902-100
3/4" 4x8	MDF CORE A1 DOMESTIC SM&N	228-903-500
3/4" 4x10	MDF CORE A1 DOMESTIC SM&N	228-904-500
1" 4x10	MDF CORE A1 NSB DOMESTIC SM&N	228-905-000
1/2" 4x8	COMBI-CORE A1 NSB DOMESTIC	228-901-500
3/4" 4x8	COMBI-CORE A1 NSB DOMESTIC	228-902-500
3/4" 4x8	COMBI-CORE A1 NSB DOMESTIC SM&N	228-902-750
3/4" 4x10	COMBI-CORE A1 DOMESTIC SM&N	228-904-000

VENEERS

2x8	PSA	830-011-796
4x8	10MIL PREMIUM	830-011-800
4x10	10MIL PREMIUM	830-011-815
4x8	2PLY PREMIUM	830-011-850
4x10	2PLY PREMIUM	830-011-855



QUARTER SAWN

WALNUT

—QUARTER SAWN—

1/4" 4x8	MDF CORE A4 DOMESTIC	228-950-500
1/2" 4x8	MDF CORE A1 NSB DOMESTIC SM&N	228-951-000
3/4" 4x8	MDF CORE A1 NSB DOMESTIC SM&N	228-952-000
3/4" 4x10	MDF CORE SHOP	228-953-450
3/4" 4x10	MDF CORE A1 NSB DOMESTIC SM&N	228-953-500
3/4" 4x8	COMBI-CORE A1 NSB DOMESTIC SM&N	228-953-000

VENEERS

4x8	10MIL PREMIUM	830-011-900
4x8	2PLY PREMIUM	830-011-950
4x10	2PLY PREMIUM	830-011-962

A1, A4, AB, ETC. = GRADE
PS = PLAIN SLICE
BM = BOOK MATCHED
SM = SLIP MATCHED
WPF = WHOLE PIECE FACE (IDEAL FOR PAINTING)
SM&N = SEQUENCE MATCHED & NUMBERED
PSA = PRESSURE SENSITIVE ADHESIVE
10MIL = 10MIL PAPER BACKED
2PLY = 20MIL CROSSBAND WOOD BACK



Valencia
Lumber and Panel

15809 STRATHERN STREET • VAN NUYS CA • 91406

818-786-5800

SALES@VALENCIALUMBER.COM

WWW.VALENCIALUMBER.COM



PANELS & VENEERS



WALNUT

—PLAIN SAWN *PREFINISHED*—

1/4" 4x8 MDF CORE A4 DOMESTIC FINISHED 1 SIDE 226-501-107

3/4" 4x8 MDF CORE A1 DOMESTIC FINISHED 2 SIDES 226-501-125

PLAIN SAWN



SYCAMORE

—QUARTER SAWN FIGURED—

3/4" 4x8 MDF CORE A1 226-202-100

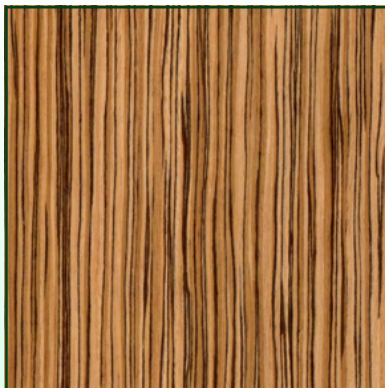

ZEBRAWOOD

—QUARTER SAWN—

3/4" 4x8 MDF CORE A1 229-951-500



Valencia
Lumber and Panel

15809 STRATHERN STREET • VAN NUYS CA • 91406



818-786-5800



SALES@VALENCIALUMBER.COM



WWW.VALENCIALUMBER.COM



A1, A4, AB, ETC. = GRADE
PS = PLAIN SLICE
BM = BOOK MATCHED
SM = SLIP MATCHED
WPF = WHOLE PIECE FACE (IDEAL FOR PAINTING)
SM&N = SEQUENCE MATCHED & NUMBERED
PSA = PRESSURE SENSITIVE ADHESIVE
10MIL = 10MIL PAPER BACKED
2PLY = 20MIL CROSSBAND WOOD BACK

CDX ▪ ACX ▪ MARINE ▪ MDO ▪ FLEX ▪ MERANTI

1/2" 4x8	CDX (15/32")	203-001-000
5/8" 4x8	CDX (19/32")	203-001-500
3/4" 4x8	CDX (23/32")	203-002-000
1/4" 4x10	ACX (7/32")	203-101-000
3/8" 4x8	ACX (11/32")	203-101-500
1/2" 4x10	ACX (15/32")	203-102-250
5/8" 4x10	ACX (19/32")	203-103-100
3/4" 4x10	ACX (23/32")	203-103-540
1/4" 4x8	ACX RADIATA PINE (7/32")	203-100-500
1/2" 4x8	ACX RADIATA PINE (15/32")	203-102-000
5/8" 4x8	ACX RADIATA PINE (19/32")	203-103-000
3/4" 4x8	ACX RADIATA PINE (23/32")	203-103-500
1" 4x8	ACX RADIATA PINE (31/32")	203-104-011
3/4" 4x8	ACX FIRE RETARDED INTERIOR (23/32")	203-103-525
5/8" 4x8	SANDED SHOP (19/32")	203-102-900
3/4" 4x8	SANDED SHOP (23/32")	203-103-400
1 1/8" 4x8	STURDY FLOOR T&G	203-002-500
1/4" 4x8	MARINE PLY	203-200-400
1/2" 4x8	MARINE PLY	203-200-450
3/4" 4x8	MARINE PLY	203-200-500
3/4" 4x10	MARINE PLY	203-200-525
1/2" 4x8	MDO 2 SIDED	203-300-500
3/4" 4x8	MDO 2 SIDED	203-301-000
3/4" 4x10	MDO 2 SIDED	203-301-100
3MM 4x8	FLEX/BENDING PLY LONG GRAIN	230-001-000
3MM 8x4	FLEX/BENDING PLY SHORT GRAIN	230-001-500
2.7MM 8x4	FLEX/BENDING PLY SHORT GRAIN	230-001-550
9MM 4x8	FLEX/BENDING PLY LONG GRAIN	230-003-000
9MM 8x4	FLEX/BENDING PLY SHORT GRAIN	230-003-500
2.7MM 4x8	MERANTI VENEER CORE	231-001-250
5.2MM 4x8	MERANTI VENEER CORE	231-001-600
5.2MM 4x10	MERANTI VENEER CORE	231-002-000



Valencia
Lumber and Panel

15809 STRATHERN STREET • VAN NUYS CA • 91406

☎ 818-786-5800

✉ SALES@VALENCIALUMBER.COM

🌐 WWW.VALENCIALUMBER.COM



MDF - MEDEX - EXTIRA - PARTICLE BOARD

MDF PREMIUM MEDIUM DENSITY FIBERBOARD

3MM	4x8	201-200-500
6MM	4x10	201-201-240
6MM	5x10	201-201-300
1/4"	4x8	201-201-000
1/4"	4x10	201-201-250
3/8"	4x8	201-201-750
3/8"	4x10	201-201-800
1/2"	4x8	201-202-250
1/2"	4x10	201-202-750
1/2"	5x10	201-202-790
5/8"	4x8	201-203-250
5/8"	4x10	201-203-300
5/8"	5x8	201-203-310
11/16"	4x8	201-203-400
11/16"	5x8	201-203-410
3/4"	4x8	201-203-750
3/4"	4x10	201-204-500
3/4"	5x8	201-204-600
3/4"	5x10	201-204-750
3/4"	4x16	201-204-800
7/8"	4x8	201-204-900
7/8"	5x9	201-204-920
1"	4x8	201-205-500
1"	4x10	201-205-750
1"	5x8	201-205-760
1"	5x10	201-205-765
1 1/4"	5x8	201-206-290
1 1/4"	5x10	201-206-300
1 1/2"	5x8	201-206-760

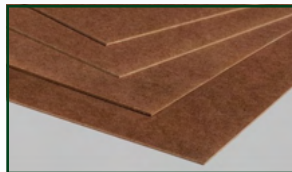
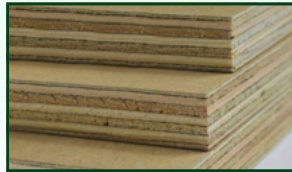

EXTIRA
by JELD-WEN

ULTRA-CORE COMBI-CORE WITH MDF FACES

1/2"	4x8	201-220-500
3/4"	4x8	201-221-000
3/4"	4x10	201-221-250
1"	4x8	201-221-500

HDM HIGH DENSITY MACHINING GRADE FIBERBOARD

3/4"	4x8	201-203-765
-------------	------------	-------------

ULTRA-LIGHT MDF

1/2"	4x8	(12MM)	201-100-500
1/2"	4x10	(12MM)	201-101-000
1/2"	5x12	(12MM)	201-101-050
3/4"	4x8	(18MM)	201-101-500
3/4"	4x10	(18MM)	201-102-000
3/4"	5x12	(18MM)	201-105-550
1"	4x8	(25MM)	201-103-000
1"	4x10	(25MM)	201-103-500
1-3/16"	4x8	(30MM)	201-104-000

MEDEX MOISTURE RESISTANT MDF

1/4"	4x8	201-201-050
3/8"	4x8	201-201-775
1/2"	4x8	201-202-400
1/2"	4x10	201-202-780
3/4"	4x8	201-203-770
3/4"	4x10	201-204-510
1"	4x8	201-205-550
1 1/4"	4x8	201-206-285

EXTIRA HIGHLY MOISTURE RESISTANT MDF

1/2"	4x8	202-000-025
1/2"	2x16	202-000-050
1/2"	4x16	202-000-060
5/8"	4x8	202-000-075
3/4"	4x8	202-000-125
3/4"	2x16	202-000-150
3/4"	4x16	202-000-175
1"	4x8	202-000-250

MISCELLANEOUS

1/8"	4x8 TEMP. HARDBOARD	200-200-600
1/4"	4x8 TEMP. HARDBOARD	200-201-000
1/4"	4x8 WHITE MARKER BRD	200-201-500
3/4"	4x8 IND. PARTICLE BOARD	200-251-500
1"	4x8 IND. PARTICLE BOARD	200-251-700



Valencia
Lumber and Panel

15809 STRATHERN STREET • VAN NUYS CA • 91406

818-786-5800

SALES@VALENCIALUMBER.COM

WWW.VALENCIALUMBER.COM



MELAMINE

ALMOND

1/4" 4x8 MDF 1S 210-501-000
 3/4" 4x8 PB 2S 210-503-000

ANTIQUE WHITE

1/4" 4x8 MDF 1S 212-600-500
 3/4" 4x8 PB 2S 212-603-000

BLACK

1/4" 4x8 MDF 1S 210-601-000
 1/2" 4x8 PB 2S 210-601-500
 3/4" 4x8 PB 2S 210-603-000
 3/4" 4x8 CC 2S 210-603-025
 3/4" 4x10 PB 2S 210-603-050
 1" 4x8 PB 2S 210-603-060

CHARCOAL

1/4" 4x8 MDF 1S 210-650-100
 1/2" 4x8 PB 2S 210-650-200
 5/8" 4x8 PB 2S 210-650-280
 3/4" 4x8 PB 2S 210-650-300
 3/4" 4x8 CC 2S 210-650-310

STORM

1/4" 4x8 MDF 1S 210-650-330
 1/2" 4x8 PB 2S 210-650-340
 5/8" 4x8 PB 2S 210-650-345
 3/4" 4x8 PB 2S 210-650-350
 3/4" 4x8 CC 2S 210-650-360

OPTI GRAY

1/4" 4x8 MDF 1S 212-004-100
 1/2" 4x8 PB 2S 212-004-200
 5/8" 4x8 PB 2S 212-004-250
 3/4" 4x8 PB 2S 212-004-300
 3/4" 4x8 CC 2S 212-004-310
 1" 4x8 PB 2S 212-004-312

FOLKSTONE

1/4" 4x8 MDF 1S 212-004-320
 1/2" 4x8 PB 2S 212-004-330
 3/4" 4x8 PB 2S 212-004-340
 3/4" 4x8 CC 2S 212-004-350

HARD ROCK MAPLE

1/4" 4x8 MDF 1S FOIL 212-450-500
 1/4" 4x8 MDF 1S 212-452-000
 1/2" 4x8 PB 2S 212-452-500
 3/4" 4x8 PB 2S 212-455-500
 3/4" 4x8 CC 2S 212-456-600
 3/4" 4x10 PB 2S 212-457-000
 1" 4x8 PB 2S 212-457-500

WHITE

1/4" 4x8 MDF 1S 212-701-000
 1/4" 4x8 MDF 2S 212-702-000
 1/4" 4x10 MDF 1S 212-702-250
 1/2" 4x8 PB 2S 212-702-500
 5/8" 4x8 PB 2S 212-704-000
 18MM 4x8 CC 2S IMPORT CAB LINER 212-704-050
 3/4" 4x8 IND PB 1S W/GLUE BACK 212-705-000
 3/4" 4x8 PB 2S 212-705-500
 3/4" 4x8 IND PB 2S 212-706-000
 3/4" 4x8 CC 2S 212-706-700
 3/4" 4x10 PB 2S 212-707-000
 1" 4x8 PB 2S 212-704-500

ADHESIVES ON PAGES 53 - 54
 EDGE-BANDING ON PAGES 587- 62
 VENEER & LAMINATE SLITTER ON PAGE 97



Valencia
Lumber and Panel

15809 STRATHERN STREET • VAN NUYS CA • 91406

818-786-5800

SALES@VALENCIALUMBER.COM

WWW.VALENCIALUMBER.COM



TEXTURED MELAMINE



CLOUD CAP

1/4" 4x8
212-708-125
3/4" 4x8
212-708-150



DUTTON CREEK

1/4" 4x8
212-708-425
3/4" 4x8
212-708-450

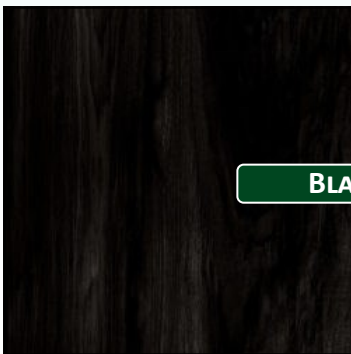

BLACK

1/4" 4x8
212-708-125
3/4" 4x8
212-708-150

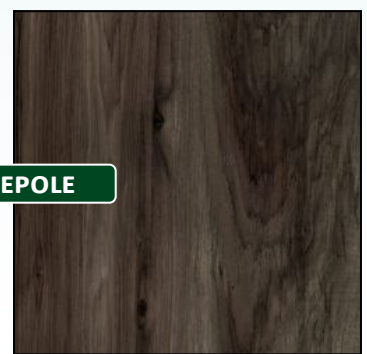

LODGEPOLE

1/4" 4x8
212-708-325
3/4" 4x8
212-708-350



DRIFTWOOD

1/4" 4x8
212-708-275
3/4" 4x8
212-708-300



MERRIAM

1/4" 4x8
212-708-525
3/4" 4x8
212-708-550



Valencia
Lumber and Panel

15809 STRATHERN STREET • VAN NUYS CA • 91406

1/4" - SINGLE SIDED MDF CORE

3/4" - DOUBLE SIDED PARTICLE BOARD CORE

818-786-5800

SALES@VALENCIALUMBER.COM

WWW.VALENCIALUMBER.COM



TEXTURED MELAMINE



OVERLOOK

1/4" 4x8
212-708-375
3/4" 4x8
212-708-400



UNION PEAK

1/4" 4x8
212-708-175
3/4" 4x8
212-708-200



PHANTOM SHIP

1/4" 4x8
212-708-225
3/4" 4x8
212-708-250

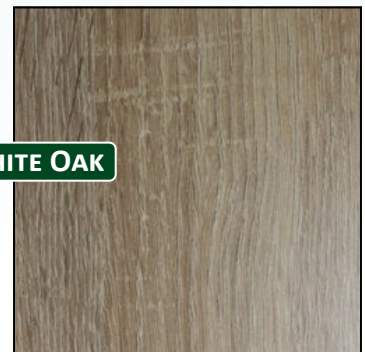

VLC WHITE OAK

1/4" 4x8
212-708-555
3/4" 4x8
212-708-560

ADHESIVES ON PAGES 53 - 54
EDGE-BANDING ON PAGES 57 - 62
VENEER & LAMINATE SLITTER ON PAGE 97



STEEL BAY

1/4" 4x8
212-708-075
3/4" 4x8
212-708-100

ALSO AVAILABLE BY SPECIAL ORDER

SALT INTERNATIONAL
ITALIAN PANELS
FENIX ■ SAVIOLA ■ HIGH GLOSS

PLEASE CONTACT OUR SALES
DEPARTMENT FOR INFORMATION



Valencia
Lumber and Panel

15809 STRATHERN STREET • VAN NUYS CA • 91406

1/4" - SINGLE SIDED MDF CORE

3/4" - DOUBLE SIDED PARTICLE BOARD CORE

818-786-5800

SALES@VALENCIALUMBER.COM

WWW.VALENCIALUMBER.COM



MELAMINE

PRE-CUT

CABINET & CLOSET PANELS

3/4" x 97" LENGTHS, BANDED ONE EDGE, WITH OR WITHOUT INLINE BORING

WHITE

12" NO BORE	810-000-050
12" BORED 1 SIDE	810-000-100
16" NO BORE	810-000-125
16" BORED 1 SIDE	810-000-150
16" BORED 2 SIDES	810-000-160
24" NO BORE	810-000-175
24" BORED 1 SIDE	810-000-200

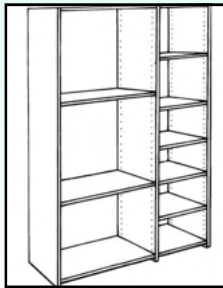
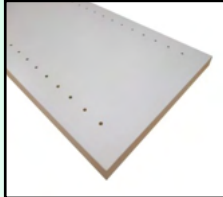

HARD ROCK MAPLE

12" NO BORE	810-000-225
12" BORED 1 SIDE	810-000-250
16" NO BORE	810-000-275
16" BORED 2 SIDES	810-000-310
24" NO BORE	810-000-325
24" BORED 1 SIDE	810-000-350

CLOSET RODS, SUPPORTS, AND SHELF PINS ON PAGES 77 & 78

FORMICA

WHITE

4x8	949-1258 MATTE POST	227-000-150
4x10	949-1258 MATTE POST	227-000-160

BLACK

4x8	909-1258 MATTE POST	227-000-170
4x10	909-1258 MATTE POST	227-000-180

FOG GRAY

4x8	961-58 MATTE POST	227-000-190
4x10	961-58 MATTE POST	227-000-210

HARD ROCK MAPLE

4x8	86992-1258 POST	227-000-220
4x10	86992-1258 POST	227-000-230



Valencia
Lumber and Panel

15809 STRATHERN STREET • VAN NUYS CA • 91406

POST FORMING WITH A SELF-EDGE AND NEED TO STRIP LAMINATE FAST, CLEAN, AND EFFICIENTLY? THEN CHECK OUT THE VENEER & LAMINATE SLITTER ON PAGE 105



818-786-5800



SALES@VALENCIALUMBER.COM



WWW.VALENCIALUMBER.COM



CORE SAMPLES

MDF CORE



COMBI CORE



EURO CORE



VENEER CORE



MARINE CORE



PARTICLE BOARD CORE



ALBA CORE



IMPORT CORE



*FUN FACT:
TREES NEVER DIE OF OLD AGE. TREES ONLY DIE FROM
EXTERNAL SOURCES LIKE INSECTS,
DISEASES, FIRE, AND PEOPLE.*



Valencia
Lumber and Panel

15809 STRATHERN STREET • VAN NUYS CA • 91406



818-786-5800



SALES@VALENCIALUMBER.COM



WWW.VALENCIALUMBER.COM



FASTENERS

FLAT HEAD

COARSE THREAD
PHILLIPS DRIVE
ZINC PLATED



- 6 x 1/2" 1000 CT. 803-500-010
- 6 x 5/8" 1000 CT. 802-500-020
- 6 x 3/4" 1000 CT. 802-500-031

FLAT HEAD

Coarse Thread
Phillips Drive
Nickel Plated



- 7 x 5/8" 100 CT. 802-501-515
- 7 x 5/8" 1000 CT. 802-501-520
- 7 x 3/4" 100 CT. 802-501-525

POCKET SCREWS

Square Drive
Plain Steel
Type 17 Auger Point Tip



- 6 x 1 1/4" FINE 1000 CT. 802-500-710
- 7 x 1 1/4" COARSE 1000 CT. 802-500-720
- 6 x 1 1/2" FINE 1000 CT. 802-500-725
- 6 x 1 1/2" COARSE 1000 CT. 802-500-735

DRAWER FRONT SCREWS

WASHER HEAD
PHILLIPS DRIVE
COARSE THREAD
ZINC PLATED



- 8 x 1" 55 CT. 802-501-206
- 8 x 1 1/8" 45 CT. 802-501-211
- 8 x 1 1/4" 50 CT. 802-501-216

INSTALLATION SCREWS

ROUND WASHER HEAD
COMBO DRIVE ZINC PLATED
COARSE THREAD
TYPE 17 AUGER POINT TIP



- 10 x 3" 50 CT. 802-500-499
- 10 x 3" 500 CT. 802-500-502
- 10 x 3" 1500 CT. 802-500-504

FLAT HEAD

COARSE THREAD W/ NIBS PHILLIPS
DRIVE
ZINC PLATED
TYPE 17 AUGER POINT TIP



- 8 x 1" 1000 CT. 802-500-505
- 8 x 1 1/4" 1000 CT. 802-500-515
- 8 x 1 1/4" 9000 CT. 802-500-513
- 8 x 1 1/2" 1000 CT. 802-500-525
- 8 x 1 1/2" 7000 CT. 802-500-523
- 8 x 1 5/8" 1000 CT. 802-500-527
- 8 x 1 5/8" 6000 CT. 802-500-528
- 8 x 1 3/4" 1000 CT. 802-500-535
- 8 x 1 3/4" 5000 CT. 802-500-533
- 8 x 2" 1000 CT. 802-500-545
- 8 x 2" 4000 CT. 802-500-543
- 8 x 2 1/4" 1000 CT. 802-500-555
- 8 x 2 1/4" 3000 CT. 802-500-553
- 8 x 2 1/2" 500 CT. 802-500-565
- 8 x 2 1/2" 2500 CT. 802-500-563
- 9 x 3" 500 CT. 802-500-575
- 9 x 3" 2000 CT. 802-500-573

QUICK RELEASE

2 3/4" MAGNETIC INSERT TIP
HOLDER
3 PACK
802-505-045



INSERT TIPS



#2 PHILLIPS

- 1" 10 PACK 802-505-005
- 2" 10 PACK 802-505-015
- 1" 10 PACK* 802-505-010
- *REDUCED TIP

#2 SQUARE DRIVE

- 1" 10 PACK 802-505-025
- 2" 10 PACK 802-505-035
- 6" SINGLE 802-505-036

T15 TORX

- 1" 10 PACK 802-760-311
- 2" 10 PACK 802-760-315

T30 TORX

- 2" SINGLE 802-505-001



Valencia
Lumber and Panel

15809 STRATHERN STREET • VAN NUYS CA • 91406



818-786-5800



SALES@VALENCIALUMBER.COM



WWW.VALENCIALUMBER.COM



FASTENERS

HEADLESS MICRO-PINS

23 GAUGE
10,000 PER BOX

- 1/2" 802-702-050
- 5/8" 802-702-060
- 3/4" 802-702-070
- 1" 802-702-080
- 1-3/16" 802-702-100
- 1-3/8" 802-702-110

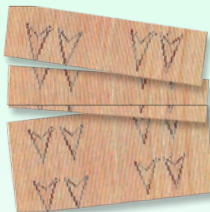

GALVANIZED STAPLES

18 GAUGE
1/4" CROWN
5,000 PER BOX

- 1/2" 802-700-050
- 5/8" 802-700-060
- 3/4" 802-700-070
- 7/8" 802-700-080
- 1" 802-700-090
- 1-1/8" 802-700-100
- 1-1/4" 802-700-110
- 1-1/2" 802-700-120

GALVANIZED BRADS

18 GAUGE
5,000 PER BOX

- 1" 802-701-080
- 1-1/4" 802-701-090
- 1-1/2" 802-701-100
- 1-3/4" 802-701-110
- 2" 802-701-120

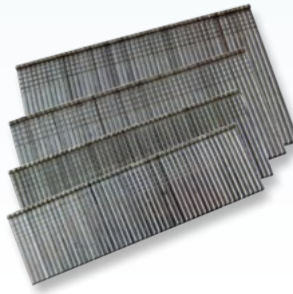

ANGLED BRADS

15 GAUGE
4,000 PER BOX

- 1-3/4" 802-701-137
- 2" 802-701-144
- 2-1/2" 802-701-151

Fits Senco Nail Guns

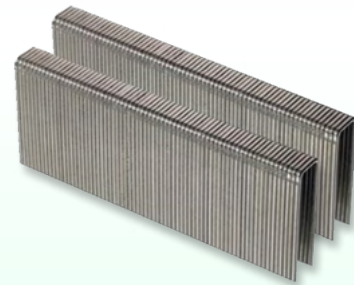
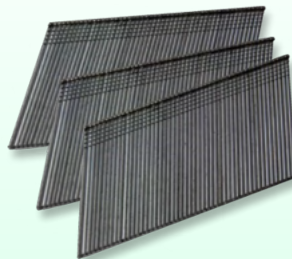

FUN FACT:
THE TERM "PENNY" IN NAIL SIZE ORIGINATED IN ENGLAND IN THE 15TH CENTURY. IT REFERRED TO THE PRICE OF 100 NAILS. FOR EXAMPLE, A 10 PENNY WOULD COST 10 CENTS PER 100 AND A 2 PENNY NAIL WOULD COST 2 CENTS PER 100.



Valencia
Lumber and Panel

15809 STRATHERN STREET • VAN NUYS CA • 91406

818-786-5800

SALES@VALENCIALUMBER.COM

WWW.VALENCIALUMBER.COM



ADHESIVES - ABRASIVES - FILLERS

TITEBOND ORIGINAL WOOD GLUE INTERIOR USE

- 16 OZ 840-200-010
- 1 GALLON 840-200-020
- 2.15 GALLON 840-200-025
- 5 GALLON 810-200-030



TITEBOND II PREMIUM WOOD GLUE WATER RESISTANT

- 16 OZ 840-200-100
- 1 GALLON 840-200-110
- 2.15 GALLON 840-200-115
- 5 GALLON 810-200-120



TITEBOND III ULTIMATE WOOD GLUE WATERPROOF

EXCELLENT CHOICE FOR BONDING TEAK

- 16 OZ 840-200-150
- 1 GALLON 840-200-160
- 2.15 GALLON 840-200-165
- 5 GALLON 810-200-170



TITEBOND MELAMINE GLUE INTERIOR USE

- 16 OZ 840-200-250
- 1 GALLON 840-200-260



SILICONE SEALANT

- WHITE 840-200-360
- CLEAR 840-200-370



PRO GRADE CAULK

- WHITE 840-200-325



LOCTITE PL PREMIUM

- HEAVY DUTY CONSTRUCTION ADHESIVE
- 840-200-356



TITEBOND PROVANTAGE

- HEAVY DUTY CONSTRUCTION ADHESIVE
- 840-200-350



TITEBOND TITEGRAB

- HEAVY DUTY CONSTRUCTION ADHESIVE
- 840-200-355



HEAVY DUTY CAULK GUN

25:1 THRUST RATIO
SAVE YOUR WRIST
802-320-200



STANDARD CAULK GUN

802-320-100

GORILLA GLUE

POLYURETHANE GLUE

- 4 OZ 840-765-006



GLUBOT

- 4 OZ 802-120-770
- 16 OZ 802-120-780



Valencia
Lumber and Panel

15809 STRATHERN STREET • VAN NUYS CA • 91406



818-786-5800



SALES@VALENCIALUMBER.COM



WWW.VALENCIALUMBER.COM



ADHESIVES - ABRASIVES - FILLERS

CONTACT CEMENT

WATER BASE

- HELMITIN 775 GALLON 840-011-500
- 3M FASTBOND 30NF QUART 840-011-475
- 3M FASTBOND 30NF GALLON 840-011-510
- 3M FASTBOND 30NF 5 GAL 840-011-560



HELMITIN 3M

SPRAY ADHESIVE

SOLVENT BASE

- HELMITIN 1675 15 oz 840-011-160
- 3M 20ca 15.7 oz 840-011-150



CYANOACRYLATE

SUPER GLUE
10 SECOND SET TIME



2.25 OZ ADHESIVE

- THIN 802-119-610
- MEDIUM 802-119-570
- THICK 802-119-590
- JEL 802-119-550

10 OZ ADHESIVE

- THIN 802-119-605
- MEDIUM 802-119-565
- THICK 802-119-600
- JEL 802-119-545



SPRAY ACTIVATOR

12 oz 802-119-585



TITEBOND INSTANT BOND

MEDIUM JET BLACK
DEFECT FILLER

2 oz 840-200-380



FUN FACT:

ONE OF THE MOST IMPORTANT MOMENTS IN THE HISTORY OF GLUE HAPPENED IN 1942 WHEN AMERICAN INVENTOR HARRY COOVER MANAGED TO ACCIDENTALLY CREATE CYANOACRYLATE (WHILE MAKING CLEAR PLASTIC GUNSIGHTS) WHICH IS KNOWN TODAY AS SUPER GLUE. HE RELEASED IT FOR COMMERCIAL USE IN 1958.



Valencia
Lumber and Panel

15809 STRATHERN STREET • VAN NUYS CA • 91406



818-786-5800



SALES@VALENCIALUMBER.COM



WWW.VALENCIALUMBER.COM



ADHESIVES - ABRASIVES - FILLERS

SANDING DISCS

5" HOOK & LOOP ▪ 8 HOLE ▪ 50/BOX
NON-LOADING ALUMINUM OXIDE

- 80 GRIT** 850-010-101
- 100 GRIT** 850-010-103
- 120 GRIT** 850-010-105
- 180 GRIT** 850-010-107
- 220 GRIT** 850-010-109



SERIOUS GRIT

OSCILLATING MULTI-TOOL DELTA PAD SANDPAPER

NON-LOADING ALUMINUM OXIDE
6 HOLE ▪ 10 PACK

- 80 GRIT** 820-002-124
- 100 GRIT** 820-002-125
- 120 GRIT** 820-002-126
- 180 GRIT** 820-002-127



FAST BREAK
EDGE BREAKER
802-120-480



FAST BREAK
10 PACK REFILLS

- 80 GRIT** 802-120-505
- 180GRIT** 820-120-500

OSCILLATING MULTI-TOOL DELTA SANDING PAD

STARLOCK
820-002-123



Valencia
Lumber and Panel

15809 STRATHERN STREET • VAN NUYS CA • 91406

*FUN FACT:
SOFTWOODS COME FROM GYMNOSPERM TREES
(EVERGREENS) WHILE HARDWOODS COME FROM
ANGIOSPERM TREES (DECIDUOUS).*

☎ 818-786-5800

✉ SALES@VALENCIALUMBER.COM

🌐 WWW.VALENCIALUMBER.COM



ADHESIVES - ABRASIVES - FILLERS

TIMBER MATE

WATER BASE WOOD FILLER

8 OZ JAR

ALDER	710-150-320
AMERICAN CHERRY	710-150-230
BRAZILIAN CHERRY	710-150-220
CHESTNUT	710-150-200
EBONY	710-150-280
MAHOGANY	710-150-240
MAPLE	710-150-250
RED OAK	710-150-270
TASMANIAN OAK	710-150-330
TEAK	710-150-210
TINT BASE	710-150-260
WALNUT	710-150-290
WHITE	710-150-300
WHITE OAK	710-150-310

4 LB TUB

ALDER	710-150-325
BRAZILIAN CHERRY	710-150-225
EBONY	710-150-285
MAPLE	710-150-255
RED OAK	710-150-275
TEAK	710-150-215
TINT BASE	710-150-265
WALNUT	710-150-295
WHITE	710-150-305
WHITE OAK	710-150-315

16 LB BUCKET

MAPLE	710-150-257
WHITE OAK	710-150-317



Timbermate®



Valencia
Lumber and Panel

15809 STRATHERN STREET • VAN NUYS CA • 91406

TIMBER MATE EARL'S MULTIFILL

8 OZ JAR 710-150-340
4 LB TUB 710-150-345



READY TO USE - INDOOR & OUTDOOR

EARL'S MULTI-PURPOSE MULTIFILL IS THE PERFECT FILLER TO FILL INTERIOR OR EXTERIOR SURFACES SUCH AS WOOD, ROTTED TIMBER, MASONRY, PLASTER BOARD, CEMENT SHEET, CONCRETE, METAL AND MORE. EARL'S MULTIFILL IS AVAILABLE IN WHITE, WHICH IS GREAT FOR PAINTED SURFACES.

3M LIGHTWEIGHT FILLER (BONDO)

QUART 710-100-025



WAXSTIX

TOUCH-UP CRAYONS

ALDER	710-151-005
BRAZILIAN CHERRY	710-151-025
EBONY	710-151-010
MAHOGANY	710-151-015
MAPLE/BEECH/PINE	710-151-035
NATURAL	710-151-030
TASMANIAN OAK	710-151-020
TEAK	710-151-040
WALNUT	710-151-045
WHITE	710-151-050



WAXSTIX ARE SO EASY TO USE AND SO HANDY FOR NAIL HOLES & QUICK REPAIRS TO SCRATCHED OR DAMAGED TIMBER. WAXSTIX CAN BE COATED AND STAINED. PLUS, WAXSTIX CONTAIN NO BEESWAX SO THEY WILL NOT LEAVE ANY WHITE RING MARKING OTHERWISE KNOWN AS THE "HALO EFFECT"

818-786-5800

SALES@VALENCIALUMBER.COM

WWW.VALENCIALUMBER.COM



EDGE-BANDING

—WOOD VENEER EDGE-BANDING—

ALDER

.5MM x 7/8" x 500' 826-021-125
UNFINISHED, PLAIN SAWN, NO GLUE

.5MM x 7/8" x 250' 826-021-150
UNFINISHED, PLAIN SAWN, PRE-GLUED

.5MM x 1 1/8" x 500' 826-021-152
UNFINISHED, PLAIN SAWN, NO GLUE

.5MM x 1 1/8" x 250' 826-021-154
UNFINISHED, PLAIN SAWN, PRE-GLUED

1MM x 7/8" x 328' 826-021-130
UNFINISHED, PLAIN SAWN, NO GLUE

AFRICAN MAHOGANY

.5MM x 7/8" x 500' 826-021-525
UNFINISHED, PLAIN SAWN, NO GLUE

.5MM x 7/8" x 250' 826-021-550
UNFINISHED, PLAIN SAWN, PRE-GLUED

1MM x 7/8" x 328' 826-021-530
UNFINISHED, PLAIN SAWN, NO GLUE

ASH

.5MM x 7/8" x 500' 826-021-190
UNFINISHED, PLAIN SAWN, NO GLUE

.5MM x 7/8" x 250' 826-021-200
UNFINISHED, PLAIN SAWN, PRE-GLUED

BEECH

.5MM x 7/8" x 500' 826-021-225
UNFINISHED, PLAIN SAWN, NO GLUE

.5MM x 7/8" x 250' 826-021-250
UNFINISHED, PLAIN SAWN, PRE-GLUED

BIRCH WHITE

.5MM x 7/8" x 500' 826-021-325
UNFINISHED, PLAIN SAWN, NO GLUE

.5MM x 7/8" x 250' 826-021-350
UNFINISHED, PLAIN SAWN, PRE-GLUED

.5MM x 7/8" x 500' 826-020-000
PREFINISHED, PLAIN SAWN, NO GLUE

.5MM x 7/8" x 250' 826-021-000
PREFINISHED, PLAIN SAWN, PRE-GLUED

CHERRY

.5MM x 7/8" x 500' 826-021-375
UNFINISHED, PLAIN SAWN, NO GLUE

.5MM x 7/8" x 250' 826-021-400
UNFINISHED, PLAIN SAWN, PRE-GLUED

DOUGLAS FIR

.5MM x 7/8" x 500' 826-021-425
UNFINISHED, VERTICAL GRAIN, NO GLUE

.5MM x 7/8" x 250' 826-021-450
UNFINISHED, VERTICAL GRAIN, PRE-GLUED

.6MM x 7/8" x 500' 826-022-050
UNFINISHED, RECON VERTICAL GRAIN, NO GLUE

MAPLE

.5MM x 5/8" x 500' 826-021-570
UNFINISHED, PLAIN SAWN, NO GLUE

.5MM x 5/8" x 250' 826-021-571
UNFINISHED, PLAIN SAWN, PRE-GLUED

.5MM x 7/8" x 500' 826-021-575
UNFINISHED, PLAIN SAWN, NO GLUE

.5MM x 7/8" x 250' 826-021-600
UNFINISHED, PLAIN SAWN, PRE-GLUED

**NEED 2" WIDE EDGE-BANDING?
WE CAN SPECIAL ORDER FOR YOU, OR GET
THE VENEER SLITTER ON PAGE 98 AND
MAKE YOUR OWN WITH VENEER!**



Valencia
Lumber and Panel

15809 STRATHERN STREET • VAN NUYS CA • 91406

 818-786-5800

 SALES@VALENCIALUMBER.COM

 WWW.VALENCIALUMBER.COM



EDGEBANDING

—WOOD VENEER EDGE BANDINGS—

MAPLE

.5MM X 5/8" X 500' 826-021-570
UNFINISHED, PLAIN SAWN, NO GLUE

.5MM X 5/8" X 250' 826-021-571
UNFINISHED, PLAIN SAWN, PRE-GLUED

.5MM X 7/8" X 500' 826-021-575
UNFINISHED, PLAIN SAWN, NO GLUE

.5MM X 7/8" X 250' 826-021-600
UNFINISHED, PLAIN SAWN, PRE-GLUED

.5MM X 1 1/8" X 500' 826-021-601
UNFINISHED, PLAIN SAWN, NO GLUE

.5MM X 1 1/8" X 250' 826-021-602
UNFINISHED, PLAIN SAWN, PRE-GLUED

1MM X 7/8" X 328' 826-021-580
UNFINISHED, PLAIN SAWN, NO GLUE

.5MM X 5/8" X 500' 826-021-070
PREFINISHED, PLAIN SAWN, NO GLUE

.5MM X 5/8" X 250' 826-021-071
PREFINISHED, PLAIN SAWN, PRE-GLUED

.5MM X 7/8" X 500' 826-021-075
PREFINISHED, PLAIN SAWN, NO GLUE

.5MM X 7/8" X 250' 826-021-100
PREFINISHED, PLAIN SAWN, PRE-GLUED

.5MM X 1 1/8" X 500' 826-021-103
PREFINISHED, PLAIN SAWN, NO GLUE

.5mm x 1 1/8" x 250' 826-021-104
PREFINISHED, PLAIN SAWN, PRE-GLUED

RED OAK

.5MM X 7/8" X 500' 826-021-625
UNFINISHED, PLAIN SAWN, NO GLUE

.5MM X 7/8" X 250' 826-021-650
UNFINISHED, PLAIN SAWN, PRE-GLUED

SAPELE

.5MM X 7/8" X 500' 826-021-840
UNFINISHED, PLAIN SAWN, NO GLUE

.5MM X 7/8" X 250' 826-021-850
UNFINISHED, PLAIN SAWN, PRE-GLUED

TEAK

.5MM X 7/8" X 500' 826-021-890
UNFINISHED, PLAIN SAWN, NO GLUE

.5MM X 7/8" X 250' 826-021-900
UNFINISHED, PLAIN SAWN, PRE-GLUED

.5MM X 7/8" X 500' 826-021-910
UNFINISHED, QUARTER SAWN, NO GLUE

.5MM X 7/8" X 250' 826-021-915
UNFINISHED, QUARTER SAWN, PRE-GLUED

WALNUT

.5MM X 7/8" X 500' 826-021-925
UNFINISHED, PLAIN SAWN, NO GLUE

.5MM X 7/8" X 250' 826-021-950
UNFINISHED, PLAIN SAWN, PRE-GLUED

.5MM X 1 1/8" X 500' 826-021-953
UNFINISHED, PLAIN SAWN, NO GLUE

.5MM X 1 1/8" X 250' 826-021-952
UNFINISHED, PLAIN SAWN, PRE-GLUED

.5MM X 7/8" X 500' 826-021-954
UNFINISHED, QUARTER SAWN, NO GLUE

.5MM X 7/8" X 250' 826-021-955
UNFINISHED, QUARTER SAWN, PRE-GLUED

1MM X 7/8" X 328' 826-021-930
UNFINISHED, PLAIN SAWN, NO GLUE

.5MM X 7/8" X 500' 826-021-110
UNFINISHED, PLAIN SAWN, NO GLUE

.5MM X 7/8" X 250' 826-021-111
Unfinished, Plain Sawn, Pre-Glued



Valencia
Lumber and Panel

15809 STRATHERN STREET • VAN NUYS CA • 91406

 818-786-5800

 SALES@VALENCIALUMBER.COM

 WWW.VALENCIALUMBER.COM



EDGE-BANDING

—WOOD VENEER EDGE-BANDINGS—

WHITE OAK - PLAIN SAWN

.5MM x 7/8" x 500' 826-021-675
UNFINISHED, NO GLUE

.5MM x 7/8" x 250' 826-021-700
UNFINISHED, PRE-GLUED

.5MM x 1 1/8" x 500' 826-021-703
UNFINISHED, NO GLUE

.5MM x 1 1/8" x 250' 826-021-704
UNFINISHED, PRE-GLUED

1MM x 7/8" x 328' 826-021-680
UNFINISHED, NO GLUE

WHITE OAK - RIFT SAWN

.5MM x 7/8" x 500' 826-021-705
UNFINISHED, NO GLUE

.5MM x 7/8" x 250' 826-021-710
UNFINISHED, PRE-GLUED

.5MM x 1 1/8" x 500' 826-021-712
UNFINISHED, NO GLUE

.5MM x 1 1/8" x 250' 826-021-715
UNFINISHED, PRE-GLUED

1MM x 7/8" x 328' 826-021-707
UNFINISHED, NO GLUE



VENEER & LAMINATE SLITTER
820-002-583

CREATE YOUR OWN EDGE-BANDING
CUTTING WIDTH 1/2" TO 4-1/4"
THICKNESS UP TO 5/64"



EDGE-BANDING TRIMMER
820-002-583

TRIMS EDGE-BANDING ON PANELS
BETWEEN 1/2" AND 1". EASILY
TRIMS BOTH SIDES IN ONE PASS.
THE FIRST CUTTER WILL FLUSH CUT,
THE SECOND ONE CAN BE ADJUSTED
FOR A BEVEL CUT OR FLUSH CUT.

FLUSH CUT TRIMMER

STANDARD 802-121-715
HEAVY DUTY 802-121-720



Valencia
Lumber and Panel

15809 STRATHERN STREET • VAN NUYS CA • 91406

818-786-5800

SALES@VALENCIALUMBER.COM

WWW.VALENCIALUMBER.COM



EDGEBANDING

—PVC EDGE-BANDINGS—

<p>ALMOND .5MM x 15/16" x 600' 825-010-000 NO GLUE .5MM x 13/16" x 250' 825-011-010 IRON-ON POLYESTER</p>	<p>HARD ROCK MAPLE .5MM x 15/16" x 600' 825-011-375 NO GLUE .5MM x 15/16" x 300' 825-011-400 PRE-GLUED .5MM x 1 1/8" x 600' 825-011-409 NO GLUE 1MM x 15/16" x 300' 825-011-480 NO GLUE .5MM x 13/16" x 250' 825-011-403 IRON-ON POLYESTER</p>
<p>ANTIQUE WHITE .5MM x 15/16" x 600' 825-011-525 NO GLUE</p>	
<p>BLACK .5MM x 15/16" x 600' 825-010-575 NO GLUE 1MM x 7/8" x 300' 825-011-080 NO GLUE .5MM x 13/16" x 250' 825-011-103 IRON-ON POLYESTER</p>	<p>OPTI-GRAY .5MM x 15/16" x 600' 825-011-275 NO GLUE 1MM x 15/16" x 300' 825-011-280 NO GLUE .5MM x 13/16" x 250' 825-011-303 IRON-ON POLYESTER</p>
<p>CHARCOAL .5MM x 15/16" x 600' 825-010-110 NO GLUE .5MM x 15/16" x 300' 825-010-115 PRE-GLUED 1MM x 15/16" x 300' 825-011-112 NO GLUE</p>	<p>STORM .5MM x 15/16" x 600' 825-011-320 NO GLUE 1MM x 15/16" x 300' 825-011-321 NO GLUE .5MM x 15/16" x 300' 825-011-322 PRE-GLUED</p>
<p>FOLKSTONE .5MM x 15/16" x 600' 825-011-310 NO GLUE 1MM x 15/16" x 300' 825-011-312 NO GLUE .5MM x 13/16" x 250' 825-011-315 IRON-ON POLYESTER</p>	<p>WHITE .5MM x 5/8" x 600' 825-011-570 NO GLUE .5MM x 7/8" x 600' 825-011-575 NO GLUE .5MM x 7/8" x 300' 825-011-600 PRE-GLUED .5MM x 1-5/16" x 600' 825-011-605 NO GLUE 1MM x 15/16" x 300' 825-011-603 NO GLUE .5MM x 13/16" x 250' 825-011-625 IRON-ON POLYESTER SKI WHITE</p>



Valencia
Lumber and Panel

15809 STRATHERN STREET • VAN NUYS CA • 91406

818-786-5800

SALES@VALENCIALUMBER.COM

WWW.VALENCIALUMBER.COM



EDGEBANDING

—PVC TEXTURED EDGE-BANDINGS—

MATCHES OUR CRATER LAKE COLLECTION OF TEXTURED MELAMINE ON PAGE 48 - 49

BLACK

.5MM X 15/16" X 600' 825-011-750

NO GLUE

.5MM X 15/16" X 300' 825-011-755

PRE-GLUED

CLOUD CAP

.5MM X 15/16" X 600' 825-011-775

NO GLUE

.5MM X 15/16" X 300' 825-011-780

PRE-GLUED

DRIFTWOOD

.5MM X 15/16" X 600' 825-011-760

NO GLUE

.5MM X 15/16" X 300' 825-011-770

PRE-GLUED

DUTTON CREEK

.5MM X 15/16" X 600' 825-011-835

NO GLUE

.5MM X 15/16" X 300' 825-011-840

PRE-GLUED

LODGEPOLE

.5MM X 15/16" X 600' 825-011-805

NO GLUE

.5MM X 15/16" X 300' 825-011-810

PRE-GLUED

MERRIAM

.5MM X 15/16" X 600' 825-011-860

NO GLUE

.5MM X 15/16" X 300' 825-011-865

PRE-GLUE

OVERLOOK

.5MM X 15/16" X 600' 825-011-795

NO GLUE

.5MM X 15/16" X 300' 825-011-800

PRE-GLUED

PHANTOM SHIP

.5MM X 15/16" X 600' 825-011-850

NO GLUE

.5MM X 15/16" X 300' 825-011-855

PRE-GLUED

STEEL BAY

.5MM X 15/16" X 600' 825-011-785

NO GLUE

.5MM X 15/16" X 300' 825-011-790

PRE-GLUED

UNION PEAK

.5MM X 15/16" X 600' 825-011-820

NO GLUE

.5MM X 15/16" X 300' 825-011-825

PRE-GLUED

VLC WHITE OAK

.5MM X 15/16" X 600' 825-011-870

NO GLUE

.5MM X 15/16" X 300' 825-011-875

PRE-GLUED

1MM X 15/16" X 300' 825-011-872

NO GLUE

FUN FACT:

IT'S ESTIMATED THAT THERE ARE 3.07 TRILLION TREES ON THIS PLANET. THAT'S 422 TREES PER PERSON!



Valencia
Lumber and Panel

15809 STRATHERN STREET • VAN NUYS CA • 91406

818-786-5800

SALES@VALENCIALUMBER.COM

WWW.VALENCIALUMBER.COM



EDGE-BANDING



FAST-EDGE

15/16" x 50' ROLLS
 PREFINISHED & UNFINISHED
 PEEL & STICK EDGE-BANDING

BIRCH
 UNFINISHED
 826-021-352

CHERRY
 UNFINISHED
 826-021-401

MAPLE
 UNFINISHED
 826-021-599

RED OAK
 UNFINISHED
 826-021-651

WHITE OAK
 UNFINISHED
 826-021-702



BIRCH
 PREFINISHED
 826-021-001

MAPLE
 PREFINISHED
 826-021-105

FAST-CAPS

9/16" PEEL & STICK SCREW CAPS

- ALDER** UF MB 802-102-080
- ALMOND** PVC MB 802-102-085
- ANTIQUE** PVC MB 802-102-105
- ASH** UF MB 802-102-100
- BLACK** PVC MB 802-102-130
- BIRCH** PF MB 802-102-350
- BIRCH** PF SB 802-104-965
- BIRCH** UF MB 802-102-410
- VGDF** UF MB 802-102-400
- FOG/OPTI** PVC MB 802-102-150
- FOLKSTONE** PVC MB 802-102-200
- HR MAPLE** PVC MB 802-102-180
- HR MAPLE** PVC SB 802-110-695
- HICKORY** UF MB 802-102-175
- MAHOGANY** UF MB 802-102-255
- MAPLE** UF MB 802-120-240
- MAPLE** PF MB 802-102-305
- MAPLE** PF SB 802-104-935
- PINE** UF MB 802-102-310
- RED OAK** UF MB 802-102-375
- SAPELE** UF MB 802-102-390
- TEAK** UF MB 802-102-395
- WALNUT** UF MB 802-102-405
- WALNUT** PF MB 802-102-345
- WALNUT** PVC MB 802-102-340
- WHITE** PVC MB 802-102-415
- WHITE** PVC SB 802-104-963
- WHITE OAK** UF MB 802-102-420

SPEED-TAPE

50' ROLLS DOUBLE SIDED ACRYLIC PSA



—1"—
 802-122-285

—1½"—
 802-122-260

—2"—
 802-122-290

CAN'T FIND THE FAST-CAP YOU NEED?

MAKE YOUR OWN CUSTOM SCREW CAPS WITH THE FAST-CAP
CUSTOM COLOR PUNCH KIT
 USING YOUR OWN EDGE-BANDING.
 802-120-870



UF = UNFINISHED WOOD PF = PREFINISHED WOOD
 SB = STANDARD BOX OF 1060
 MB = MINI BOX OF 260



Valencia
Lumber and Panel

15809 STRATHERN STREET • VAN NUYS CA • 91406

818-786-5800

SALES@VALENCIALUMBER.COM

WWW.VALENCIALUMBER.COM



FINISHES

INTERIOR OIL PLUS 2C THE RUBIO FLAGSHIP

PART A OIL + PART B ACCELERATOR

OIL PLUS 2C IS A HARDWAX OIL WOOD PROTECTOR THAT COLORS AND PROTECTS IN ONLY 1 SINGLE LAYER! USING ADVANCED MOLECULAR BONDING, IT PROTECTS WOOD FROM WATER, HEAT AND DAILY WEAR & TEAR. IT IS THE BEST OIL FOR WOOD FURNITURE, HARDWOOD FLOORING, TABLES, AND JUST ABOUT ANYTHING MADE OUT OF WOOD!

Rubio® MONOCOAT



- AVAILABLE IN 55 COLORS. ALL IN STOCK!
- ENHANCES THE NATURAL LOOK AND FEEL OF WOOD.
- 0% VOC. CONTAINS NO WATER OR SOLVENTS.
- NO OVERLAPS OR STARTING MARKS.
- MINIMAL USE / HIGH COVERAGE. 300-500 SQUARE FEET PER LITER.
- CAN BE APPLIED TO VIRTUALLY ALL SPECIES OF WOOD.
- GREAT WEAR. WATER AND HEAT RESISTANT.
- VERY FAST CURE TIME.
- FDA CERTIFIED FOOD SAFE. USE ON CUTTING BOARDS, CHILDREN'S TOYS, ETC.

390 ML SIZES

ANTIQUE BRONZE	705-000-021	NATURAL	705-000-628
AQUA	705-000-063	NORDIC BLUE	705-000-650
ASH GREY	705-000-046	OAK	705-000-672
BISCUIT	705-000-089	OLIVE	705-000-695
BLACK	705-000-111	OYSTER	705-000-717
BOURBON	705-000-133	PADOUK	705-000-740
CASTLE BROWN	705-000-156	PEACOCK GREEN	705-000-818
CHARCOAL	705-000-223	PINE	705-000-841
CHERRY	705-000-246	PISTACHIO	705-000-863
CHERRY CORAL	705-000-201	PURE	705-000-897
CHOCOLATE	705-000-268	RUBY	705-000-919
CINNAMON BROWN	705-000-178	SAPPHIRE	705-000-942
CITRINE	705-000-291	SAVANNAH	705-000-964
CORN SILK	705-000-323	SILVER GREY	705-000-987
COTTON WHITE	705-000-336	SKY GREY	705-001-009
DARK OAK	705-000-381	SLATE GREY	705-001-032
DC SMOKE	705-000-356	SMOKE	705-001-054
EMERALD	705-000-403	SMOKE 5%	705-001-077
GRIS BELGE	705-000-425	SMOKED OAK	705-001-099
HAVANA	705-000-448	STONE	705-001-122
ICE BROWN	705-000-470	SUPER WHITE	705-001-144
MAHOGANY	705-000-493	TITANIUM GREY	705-001-167
MIDNIGHT INDIGO	705-000-515	TOUCH OF GOLD	705-001-189
MIST	705-000-538	VANILLA	705-001-211
MIST 5%	705-000-560	VELVET GREEN	705-001-234
MORNING MIST	705-000-605	WALNUT	705-001-256
MUD LIGHT	705-000-583	WHITE	705-001-279
		WHITE 5%	705-001-301

COVERS 300-500 SF/LITER

1.3 LITER SIZES

BISCUIT	705-000-077
BOURBON	705-000-122
CHARCOAL	705-000-212
CHOCOLATE	705-000-257
COTTON WHITE	705-000-324
MIST	705-000-526
MIST 5%	705-000-549
NATURAL	705-000-616
OAK	705-000-661
PURE	705-000-875
SMOKE	705-001-043
SMOKE 5%	705-001-065
WALNUT	705-001-245

3.5 LITER SIZE

PURE	705-000-886
-------------	-------------



Valencia
Lumber and Panel

15809 STRATHERN STREET • VAN NUYS CA • 91406

818-786-5800

SALES@VALENCIALUMBER.COM

WWW.VALENCIALUMBER.COM



FINISHES

Rubio[®] MONOCOAT

INTERIOR OIL PLUS 2C

20 ML
SAMPLE SIZES

ANTIQUÉ BRONZE	705-001-335
AQUA	705-001-425
ASH GREY	705-001-380
BISCUIT	705-001-470
BLACK	705-001-515
BOURBON	705-001-560
CASTLE BROWN	705-001-604
CHARCOAL	705-110-717
CHERRY	705-001-762
CHERRY CORAL	705-001-672
CHOCOLATE	705-001-807
CINNAMON BROWN	705-001-638
CITRINE	705-001-851
CORN SILK	705-001-896
COTTON WHITE	705-001-941
DARK OAK	705-002-031
DC SMOKE	705-001-986
EMERALD	705-002-076
GRIS BELGE	705-002-121
HAVANA	705-002-166
ICE BROWN	705-002-211
MAHOGANY	705-002-256
MIDNIGHT INDIGO	705-002-289
MIST	705-002-323
MIST 5%	705-002-368
MORNING MIST	705-002-447



MUD LIGHT	705-002-413
NATURAL	705-002-480
NORDIC BLUE	705-002-514
OAK	705-002-548
OLIVE	705-002-593
OYSTER	705-002-637
PADOUK	705-002-682
PEACOCK GREEN	705-002-716
PINE	705-002-750
PISTACHIO	705-002-795
PURE	705-002-851
RUBY	705-002-896
SAPPHIRE	705-002-941
SAVANNAH	705-002-986
SILVER GREY	705-003-042
SKY GREY	705-003-087
SLATE GREY	705-003-120
SMOKE	705-003-165
SMOKE 5%	705-003-210
SMOKED OAK	705-003-255
STONE	705-003-300
SUPER WHITE	705-003-345
TITANIUM GREY	705-003-390
TOUCH OF GOLD	705-003-423
VANILLA	705-003-457
VELVET GREEN	705-003-761
WALNUT	705-003-525
WHITE	705-003-569
WHITE 5%	705-003-614



Valencia
Lumber and Panel

15809 STRATHERN STREET • VAN NUYS CA • 91406



818-786-5800



SALES@VALENCIALUMBER.COM



WWW.VALENCIALUMBER.COM



FINISHES

Rubio[®]
MONOCOAT

EXTERIOR HYBRID WOOD PROTECTOR

HYBRID WOOD PROTECTOR IS A GENUINE 'MONOCOAT', SUITABLE FOR COLORING AND PROTECTING EXTERIOR WOOD IN 1 SINGLE LAYER. THE EXTERIOR OIL FINISH PROTECTS WOODEN DECKS, PATIOS, FACADES, DOORS, SHUTTERS, CARPORTS, GARDEN FURNITURE, GAZEBOS, PERGOLAS, ETC. FROM DISCOLORATION AND WEATHERING. THE EASY APPLICATION AND MAINTENANCE MAKES THIS OIL AN EXCEPTIONALLY USER-FRIENDLY PRODUCT.

- AVAILABLE IN 22 COLORS. ALL IN STOCK!
- INTEGRATED UV TECHNOLOGY.
- 0% VOC. CONTAINS NO SOLVENTS OR WATER.
- SUITABLE FOR VIRTUALLY ALL TYPE OF WOOD. CAN BE USED FOR INTERIOR USE.
- MINIMAL USE. HIGH COVERAGE. 300-500 SQUARE FEET PER LITER.
- EASY TO APPLY AND FAST DRYING.
- NOT FILM FORMING. DOES NOT CHIP, PEEL, OR FLAKE OFF.
- MAINTENANCE WITH SAME PRODUCT. NO NEED FOR SANDING

20 ML SAMPLE SIZES

AUTOCLAVE GREEN	705-003-906
BLACK	705-003-951
CHARCOAL	705-003-985
CHOCOLATE	705-004-019
DOLPHIN	705-004-063
DRAGONFRUIT	705-004-097
GREY	705-004-142
LAGOON	705-004-176
LIGHT GREY	705-004-209
LOOK IPE	705-004-243
NATURAL	705-004-277
PIGLET	705-004-311
POPPY	705-004-344
PURE	705-004-389
ROYAL	705-004-423
SUNFLOWER	705-004-456
SUNSET	705-004-490
TAUPE	705-004-524
TEAK	705-004-558
VEGGIE	705-004-591
WHITE	705-004-636
WINE RED	705-004-670



COVERS 150-300 SF/LITER

1 LITER SIZES

AUTOCLAVE GREEN	705-003-895
BLACK	705-003-929
CHARCOAL	705-003-974
CHOCOLATE	705-004-007
DOLPHIN	705-004-041
DRAGONFRUIT	705-004-086
GREY	705-004-120
LAGOON	705-004-165
LIGHT GREY	705-004-198
LOOK IPE	705-004-232
NATURAL	705-004-266
PIGLET	705-004-299
POPPY	705-004-333
PURE	705-004-367
ROYAL	705-004-412
SUNFLOWER	705-004-445
SUNSET	705-004-479
TAUPE	705-004-513
TEAK	705-004-546
VEGGIE	705-004-580
WHITE	705-004-614
WINE RED	705-004-659

2.5 LITER SIZE

PURE 705-004-378



Valencia
Lumber and Panel

15809 STRATHERN STREET • VAN NUYS CA • 91406

☎ 818-786-5800

✉ SALES@VALENCIALUMBER.COM

🌐 WWW.VALENCIALUMBER.COM



FINISHES

EXTERIOR DUROGRIT



- SUITABLE FOR ALL WOOD TYPES
- 0% VOC (DOES NOT CONTAIN ANY ORGANIC SOLVENTS)
- PLANT-BASED
- FAST-DRYING
- MAINTAINS THE NATURAL LOOK AND FEEL OF THE WOOD
- WATER AND DIRT-REPELLENT
- LONG-LASTING WEATHERING AND UV PROTECTION
- WILL NOT CRACK, PEEL OR FLAKE OFF
- OPEN PORE STRUCTURE WHICH ALLOWS THE WOOD TO BREATHE
- ONLY 1 LAYER NEEDED
- EXTRA DURABLE
- EASY TO MAINTAIN. NO NEED FOR SANDING!

DUROGRIT IS A SUSTAINABLE, WOOD FIBER FORTIFIED AND WATER SOLUBLE OIL THAT COLORS AND PROTECTS ALL EXTERIOR WOOD IN 1 SINGLE LAYER. THE FIBER GRIT TECHNOLOGY, WHERE ADDED WOOD FIBERS GIVE THE OIL ITS UNIQUE STRUCTURE, PROVIDES THE PERFECT COMBINATION BETWEEN A SATURATING AND A BREATHABLE MONOCOAT SYSTEM. THANKS TO THIS TECHNOLOGY, THE PRODUCT DOES NOT ONLY HAVE AN INCREDIBLE AND LONG-LASTING UV PROTECTION COMPARED TO OTHER EXTERIOR WOOD FINISHING PRODUCTS, BUT IT'S ALSO EXTREMELY DURABLE AND WEAR RESISTANT.

EXTERIOR WOODCREAM

WOODCREAM IS A BREATHABLE, HYDROPHOBIC, WAX-BASED CREAM THAT COLORS AND PROTECTS VERTICAL EXTERIOR WOOD AND MAKES IT WATER-REPELLENT. THE HYDROPHOBIC WOODCREAM TECHNOLOGY, IN COMBINATION WITH ITS UNIQUE CREAM STRUCTURE, OFFERS IMPORTANT PRODUCT AND APPLICATION BENEFITS. THIS MOISTURE-REGULATING CREAM PROVIDES WATER-REPELLENT AND SELF-CLEANING WOOD PROTECTION

- WAX-BASED, HYDROPHOBIC CREAM
- VOC FREE
- NON-FILM FORMING (NO FLAKING/CHIPPING)
- BREATHABLE
- LOW CONSUMPTION
- FOR VERTICAL EXTERIOR SURFACES ONLY
- 1 OR 2 LAYERS DEPENDING ON DESIRED LOOK
- DILUTABLE USING WOOD CREAM SOFTENER



EXTERIOR DUROGRIT

	30 ML	1 LITER	2.5 LITER
ATACAMA GREY	705-010-245	705-010-432	705-010-619
BISON BROWN	705-010-256	705-010-443	705-010-630
CHARRED BLACK	705-010-267	705-010-454	705-010-641
FOXY BROWN	705-010-278	705-010-465	705-010-652
GRASSLAND BEIGE	705-010-289	705-010-476	705-010-663
ROCKY UMBER	705-010-300	705-010-487	705-010-674
MONOCOAT GREEN	705-010-311	705-010-498	705-010-685
SADDLE BLACK	705-010-322	705-010-509	705-010-696
SALINAS BLUE	705-010-333	705-010-520	705-010-707
SALT LAKE GREEN	705-010-344	705-010-531	705-010-718
STEPPE LOOK	705-010-355	705-010-542	705-010-729
SUTTON GREY	705-010-366	705-010-553	705-010-740
TUZ WHITE	705-010-377	705-010-564	705-010-751
UTAH PINK	705-010-388	705-010-575	705-010-762

COVERS 80-150 SF/LITER

EXTERIOR WOODCREAM

	30 ML	1 LITER
BOLD BLACK	705-005-625	705-005-635
BURNED CHOCOLATE	705-005-647	705-005-658
COUNTRY GREEN	705-005-692	705-005-703
CREAMY WHITE	705-005-737	705-005-748
GRAVEL GREY	705-005-849	705-005-860
MOCHA CREAM	705-005-916	705-005-927
NAVY BLUE	705-005-961	705-005-961
OSLO OCHRE	705-005-984	705-005-995
RICH ALMOND	705-006-028	705-006-040
SALTED CARAMEL	705-006-051	705-006-062
SWEET TOFFEE	705-006-141	705-006-152
TIMELESS GREY	705-006-186	705-006-197
TRANSPARENT	705-006-208	705-006-209

COVERS 120-200 SF/LITER

SOFTENER

100 ML	705-006-073
1 LITER	705-006-085



Valencia
Lumber and Panel

15809 STRATHERN STREET • VAN NUYS CA • 91406



818-786-5800



SALES@VALENCIALUMBER.COM



WWW.VALENCIALUMBER.COM



FINISHES

Rubio[®] MONOCOAT



PRE-COLOR EASY

PRECOLOR EASY IS AN OPTIONAL PRETREATMENT, DESIGNED TO BE USED IN COMBINATION WITH OIL PLUS 2C, TO CREATE SPECIAL COMPLIMENTARY AND CONTRASTING EFFECTS WHILE ALLOWING THE OPTIMAL MOLECULAR BONDING OF OIL PLUS 2C WITH THE WOOD TO REMAIN GUARANTEED.

100 ML SIZES

ALPACA WHITE	705-010-036
ANTIQUE BEIGE	705-010-047
CASHMERE BROWN	705-010-058
INTENSE BLACK	705-005-130
INTENSE GREY	705-010-069
MINT WHITE	705-005-220
MONSOON GREY	705-010-080
MYSTIC BROWN	705-005-175
NORDIC WHITE	705-005-242
PEBBLE GREY	705-010-025
SMOKED BROWN	705-010-091
URBAN GREY	705-005-310
VANILLA CREAM	705-010-014
VINTAGE BROWN	705-010-003

1 LITER SIZES

INTENSE BLACK	705-005-141
NORDIC WHITE	705-005-254



FUMED

FUMED IS A TANNIN REACTIVE PRODUCT THAT IS USED ON OAK WOODS. IT REPLICATES THE AGED GREY LOOK OF WOOD WITHOUT CAUSING ANY TOXIC FUMES OR VAPORS. THE AGED LOOK ACHIEVED BY USING FUMED ALLOWS FOR THE CREATION OF UNIQUE LOOKS AND EFFECTS.

100 ML	705-004-782
1 LITER	705-004-793



PRE-AGING

PRE-AGING IS A HIGH-QUALITY, NON-REACTIVE PRE-TREATMENT, THAT GIVES WOOD AN AGED APPEARANCE. APPLICATION PROVIDES A DEEP COLOR WITH SUBTLE ACCENTS. AVAILABLE IN 10 SHADES, THE COLOR SPECTRUM RANGES FROM A LIGHTER TO A DARKER SMOKED LOOK, WITH COLORS THAT CAN BE MIXED WITH EACH OTHER TO CREATE CUSTOM LOOKS.

100 ML SIZES

AUTHENTIC 1	705-010-146
AUTHENTIC 2	705-010-157
AUTHENTIC 3	705-010-168
AUTHENTIC 4	705-010-179
AUTHENTIC 5	705-010-190
AUTHENTIC 6	705-010-201
FUMED INTENSE	705-004-951
FUMED LIGHT	705-004-973
SMOKE INTENSE	705-004-995
SMOKE LIGHT	705-004-018



ACCELERATOR

OIL PLUS PART B IS AN ACCELERATOR AND HARDENER WHICH IS USED IN COMBINATION WITH OIL PLUS PART A. IT IS INCLUDED WITH THE OIL PLUS 2C AND REDUCES THE FULL CURE TIME FROM 21 DAYS TO WITHIN 5 DAYS. IT IS ALSO RECOMMENDED TO ADD 1 PART ACCELERATOR TO 10 PARTS OF EXTERIOR *HYBRID WOOD PROTECTOR* FOR USE ON DECKS.

100 ML	705-000-751
1 LITER	705-000-753



REFRESH ECO

REFRESH ECO IS A READY-TO-USE SPRAYABLE PRODUCT THAT REFRESHES AND RESTORES ALL WOODEN SURFACES THAT HAVE BEEN TREATED WITH OIL.

.5 LITER SPRAY	705-004-704
-----------------------	-------------



Valencia
Lumber and Panel

15809 STRATHERN STREET • VAN NUYS CA • 91406



818-786-5800



SALES@VALENCIALUMBER.COM



WWW.VALENCIALUMBER.COM



FINISHES

Rubio[®] MONOCOAT



RAW WOOD CLEANER

RAW WOOD CLEANER IS A PREPARATORY CLEANER THAT THOROUGHLY CLEANS THE WOOD SURFACE AFTER SANDING AND VACUUMING BEFORE TREATING IT WITH A RUBIO MONOCOAT FINISHING OIL. REMOVES EVEN THE SMALLEST DUST PARTICLES. CAN ALSO BE USED TO CLEAN THE USED MATERIALS AFTER THE OIL APPLICATION.

100 ML 705-005-377
1 Liter 705-005-388



EXTERIOR WOOD CLEANER

EXTERIOR WOOD CLEANER IS A PRODUCT USED TO CLEAN WOODEN PATIOS, FENCES, EXTERIOR DOORS, CARPORTS, ETC... PRIOR TO BEING FINISHED WITH A RUBIO MONOCOAT EXTERIOR FINISH PRODUCT. THE PRODUCT REMOVES GREY DISCOLORATION, GREEN DEPOSITS AND DIRT.

1 LITER 705-003-704
5 Liter 705-003-715



UNIVERSAL SOAP

UNIVERSAL SOAP IS A NATURAL SOAP FOR THE REGULAR CLEANING OF OILED SURFACES. THE SOAP REMOVES ALL DIRT AND GREASE THOROUGHLY, WITHOUT AFFECTING THE MATTE, NATURAL LOOK OF THE WOOD. HIGHLY CONCENTRATED AND ECONOMICAL.

100 ML 705-003-772
1 LITER 705-003-783
KIT 705-003-805
KIT INCLUDES 100ML SOAP AND SPRAY BOTTLE



UNIVERSAL MAINTENANCE OIL (PURE)

UNIVERSAL MAINTENANCE OIL IS USED TO INCREASE THE SHEEN (APPROXIMATE SATIN) AND NOURISH WOOD FINISHED WITH RUBIO MONOCOAT OIL, GIVING IT A FULLER LOOK. ONCE UNIVERSAL MAINTENANCE OIL HAS BEEN APPLIED TO A SURFACE, FUTURE MAINTENANCE MUST BE PERFORMED USING UNIVERSAL MAINTENANCE OIL.

100 ML 705-005-568
.5 LITER 705-005-557



WOODFILLER QUICK

WOODFILLER QUICK IS A ONE-COMPONENT, SHRINK-PROOF PUTTY IN POWDER FORM FOR THE PREPARATION OF INDOOR JOINERY. IT IS SUITABLE AS A WOOD FILLER FOR FILLING KNOT HOLES, CRACKS, NAIL HOLES, AND MOST GAPS. THE LIGHT, MEDIUM, AND DARK WOOD FILLER COLORS CAN BE USED TO MATCH A SPECIES.

100 GRAM SIZES
LIGHT 705-016-238
MEDIUM 705-016-268
DARK 705-016-227



Valencia
Lumber and Panel

15809 STRATHERN STREET • VAN NUYS CA • 91406



818-786-5800



SALES@VALENCIALUMBER.COM



WWW.VALENCIALUMBER.COM



FINISHES

Rubio[®] MONOCOAT



RENEW

RENEW IS A READY-TO-USE PRODUCT THAT REFRESHES, RESTORES AND PROTECTS SURFACES TREATED WITH OIL PLUS 2C. RENEW SHOULD BE USED WHEN THE SURFACE FEELS TOO DRY OR ROUGH, OR WHEN THE FINISH HAS WORN DOWN DUE TO HEAVY USE.

100 ML 705-004-737

.5 LITER 705-004-726



TANNIN REMOVER

TANNIN REMOVER IS A READY-TO-USE PRODUCT FOR REMOVING STAINS AND SPOTS ON WOOD CAUSED BY A REACTION TO ACID AND WATER. IT CAN BE USED ON UNTREATED, OILED AND WAXED SURFACES.

.5 LITER SPRAY 705-005-445

REFRESH ECO

REFRESH ECO IS A READY-TO-USE SPRAYABLE PRODUCT THAT REFRESHES AND RESTORES ALL WOODEN SURFACES THAT HAVE BEEN TREATED WITH OIL.

.5 LITER SPRAY 705-004-704



APPLICATOR SET

1 HANDLE + 5 WHITE PADS
705-004-771



WHITE PAD

705-004-760



A WHITE APPLICATION PAD USED FOR APPLYING RUBIO MONOCOAT OILS. USE IT AS A STAND-ALONE APPLICATOR OR AS A REFILL TO THE APPLICATOR SET. THE SYNTHETIC SCRUBBY FIBERS ARE LESS ABSORPTIVE THEN A RAG, ALLOWING FOR LESS WASTE.

RED PAD

705-004-770



A RED APPLICATION PAD USED FOR APPLYING RUBIO MONOCOAT OILS. USE IT AS A STAND-ALONE APPLICATOR OR AS A REFILL TO THE APPLICATOR SET. THE SYNTHETIC SCRUBBY FIBERS ARE LESS ABSORPTIVE THEN A RAG, ALLOWING FOR LESS WASTE. FOR SURFACES THAT HAVE BEEN FUMED, WATER-POPPED, OR HAD PRE-AGING APPLIED, THE RED PADS WILL HELP TO KNOCK DOWN SOME OF THE GRAIN.



SHEENPLUS

RUBIO MONOCOAT SHEENPLUS IS A 0% VOC SHEEN ENHANCER THAT PROVIDES A DURABLE SATIN LOOK TO WOODEN SURFACES THAT HAVE BEEN FINISHED WITH RUBIO MONOCOAT OIL PLUS 2C WOOD FINISH. THIS PRODUCT MAY BE APPLIED ON ALL INDOOR WOOD SURFACES, INCLUDING FURNITURE, COUNTERTOPS, TABLES, STAIRS, WALLS, FLOORS, ETC., FINISHED WITH OIL PLUS 2C. THE COMBINATION OF THE OIL (A) AND ACCELERATOR (B) ENSURES A FAST CURE TIME, RESULTING IN EXCELLENT PROTECTION. PLUS, IT'S SOLVENT AND WATER-FREE.

APPLICATOR HANDLE

705-004-768

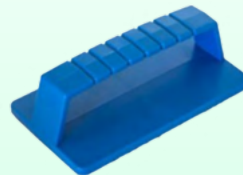

- LONG-LASTING SATIN FINISH
- NO OVERLAPPING
- HIGH SPREAD RATE
- SCRATCH-RESISTANT RESULT
- ENVIRONMENTALLY FRIENDLY WITH 0% VOC
- TO BE APPLIED BY HAND, OR USING A FLOOR BUFFER OUTFITTED WITH A PAD
- 100% SOLID CONTENT

130 ML 705-100-106

350 ML 705-100-124

1.3 LITER 705-100-139



Valencia
Lumber and Panel

15809 STRATHERN STREET • VAN NUYS CA • 91406

818-786-5800

SALES@VALENCIALUMBER.COM

WWW.VALENCIALUMBER.COM



FINISHES

INTERIOR

WATER BASE WOOD STAIN

	QUARTS
ANTIQUE BROWN	700-011-910
ANTIQUE OAK	700-010-050
BLACK	700-010-080
BLACK CHERRY	700-010-110
BROWN MAHOGANY	700-010-140
CABERNET	700-011-921
ESPRESSO	700-010-280
GRAPHITE	700-011-930
GRAYSTONE	700-011-940
HICKORY	700-011-950
NATURAL	700-010-320
ONYX	700-011-960
PECAN	700-010-350
PROVINCIAL	700-011-970
SEDONA	700-011-980
TOBACCO	700-011-990
WALNUT	700-010-440
WHITEWASH	700-010-470



**DECK, SIDING, AND
OTHER EXTERIOR
FINISHES ON PAGE 83.**

EXTERIOR

WATER BASE WOOD STAIN

	QUARTS
AGED GRAY	700-012-224
BUTTERNUT	700-012-040
CEDAR	700-012-070
CHESTNUT	700-012-100
COFFEE BEAN	700-012-130
MESQUITE	700-012-222
NATURAL BASE	700-012-130
RED MAHOGANY	700-012-220
SUGAR MAPLE	700-012-250



WOOD BOWL FINISH

OIL BASE
QUART 700-030-150



SANDING SEALER

WATER BASE
GALLON 700-028-020



BUTCHER BLOCK OIL

WHITE MINERAL OIL
PINT 700-030-200



ORANGE OIL

FURNITURE CLEANER & POLISH
PINT 700-030-275



Valencia
Lumber and Panel

15809 STRATHERN STREET • VAN NUYS CA • 91406

818-786-5800

SALES@VALENCIALUMBER.COM

WWW.VALENCIALUMBER.COM



FINISHES

—EPOXY RESIN—



ICE THIN

THIN EPOXY RESIN
1/16" - 1" THICK POURS

1 GALLON KIT 705-300-029



ICE EPOXY



ICE CAST

CASTING EPOXY RESIN
1" - 4" THICK POURS

1.5 GALLON KIT 705-300-005
3 GALLON KIT 705-300-017
15 GALLON KIT 705-300-020

- EMBEDDING & ENCAPSULATION
- CHARCUTERIE BOARDS
- SMALL CASTINGS
- BARS, TABLES, COUNTER TOPS
- FILLING WOOD CRACKS AND HOLES
- WOOD PRE-SEALING
- ART OR CRAFTING RESIN



- RIVER CASTINGS
- HIGH BUILD COATINGS
- MASS CASTINGS
- EMBEDDING & ENCAPSULATION
- RESIN JEWELRY
- MOLDING RESIN
- ART OR CRAFTING RESIN



MIXING PADDLE
11" HELIX
705-300-898



MIX STICKS
10 PACK 6"
705-300-901



MIXING BUCKET
1 QUART 705-300-905
5 QUART 705-300-916



RELEASE TAPE
2.4" x 180'
705-300-880



Valencia
Lumber and Panel

15809 STRATHERN STREET • VAN NUYS CA • 91406



818-786-5800



SALES@VALENCIALUMBER.COM



WWW.VALENCIALUMBER.COM



FINISHES

—MICA POWDER PIGMENTS—

Black Diamond

PIGMENTS

MICA POWDER PIGMENTS SPECIALLY
DESIGNED FOR EPOXY RESIN

ALUMINUM 51G	705-300-268	GHOST GREEN PEARL 42G	705-300-592
ARTIC BLUE FROST 30G	705-300-286	GHOST GOLD PEARL 51G	705-300-610
BEWITCHING DIABLO 30G	705-300-304	GOLD/ORANGE 42G	705-300-628
BLACK DIAMOND 51G	705-300-322	GREEN APPLE 51G	705-300-646
BORA BORA BLUE 51G	705-300-340	IMPERIAL BLACK ONYX 42G	705-300-664
BLOOD RED 51G	705-300-358	IMPERIAL RED/PINK 51G	705-300-682
BURPLE 51G	705-300-376	JUNGLE GREEN 51G	705-300-700
CARIBBEAN BLUE 51G	705-300-394	MERLOT 51G	705-300-718
COBALT 51G	705-300-412	OLIVE YELLOW 51G	705-300-736
COPPER PENNY 51G	705-300-430	PURE GOLD 51G	705-300-754
COTTON CANDY 30G	705-300-448	PINK PEARL 51G	705-300-572
DEEP BLUE SEA 51G	705-300-466	SAPPHIRE GHOST BLUE 51G	705-300-790
DRAGONS BREATH 51G	705-300-484	SCARLET 51G	705-300-808
EMERALD GREEN 51G	705-300-502	SILVER PEARL 51G	705-300-826
FLUORESCENT BLUE 42G	705-300-520	STIRLING ORANGE 51G	705-300-844
FLUORESCENT GREEN 51G	705-300-538	WHITE DIAMOND 51G	705-300-862
FLUORESCENT ORANGE 51G	705-300-556		



THESE PROFESSIONAL GRADE POWDER PIGMENTS ARE NON-TOXIC 10 - 60 MICRONS TITANIUM DIOXIDE AND CAN ALSO BE USED IN LACQUER, AUTOMOTIVE FINISHES, SOAP MAKING, CRAFTS, CANDLE MAKING, FIBERGLASS, PLASTIC RESINS, AND MORE!



26 COLOR VARIETY PACK #2
2G EACH/52G TOTAL
705-300-250



Valencia
Lumber and Panel

15809 STRATHERN STREET • VAN NUYS CA • 91406



818-786-5800



SALES@VALENCIALUMBER.COM



WWW.VALENCIALUMBER.COM



CABINET ORGANIZATION



LAZY SUSAN

WHITE POLYMER
2 SHELF KIDNEY
26"-31" HEIGHT
28" 861-001-010
32" 861-001-030



LAZY SUSAN

FINISHED MAPLE
2 SHELF KIDNEY
26"-31" HEIGHT
28" 861-001-050
32" 861-001-070



5" BASE PULL-OUT

FINISHED MAPLE
MINIMUM OPENING
5½"W X 25¾"H X 22½"D
861-021-090



8" BASE PULL-OUT

FINISHED MAPLE
MINIMUM OPENING
8½"W X 25¾"H X 22½"D
861-021-099



5" BASE PULL-OUT

FINISHED MAPLE
SOFT-CLOSE BLUMOTION
MINIMUM OPENING
5½"W X 25⅝"H X 22"D
861-021-108



8" BASE PULL-OUT

FINISHED MAPLE
SOFT-CLOSE BLUMOTION
MINIMUM OPENING
9"W X 25⅝"H X 22"D
861-021-117



GLIDEWARE PULL-OUT

FINISHED MAPLE
SOFT-CLOSE BLUMOTION
MINIMUM DEPTH 22¾"
861-002-069



SPICE INSERT

FOR 8" BASE
PULL-OUTS
FINISHED MAPLE
861-021-103



CHROME TRAY DIVIDER

12" HEIGHT
861-021-126
18" HEIGHT
861-021-135

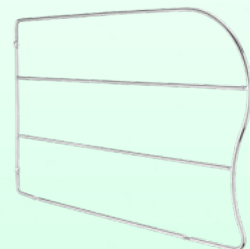

Valencia
Lumber and Panel

15809 STRATHERN STREET • VAN NUYS CA • 91406

818-786-5800

SALES@VALENCIALUMBER.COM

WWW.VALENCIALUMBER.COM



CABINET ORGANIZATION



WASTE PULL-OUT

DBL 27 QT SOFT CLOSE
MINIMUM OPENING
12"W X 19½"H X 22¼"D
WHITE
861-021-162



WASTE PULL-OUT

SINGLE 35 QT
MINIMUM OPENING
11"W X 19½"H X 22¼"D
WHITE
862-002-025



WASTE PULL-OUT

DBL 35 QT SOFT CLOSE
MINIMUM OPENING
15"W X 19½"H X 22¼"D
WHITE
861-021-150



WASTE PULL-OUT

DBL 35 QT
MINIMUM OPENING
14¾"W X 19½"H X 22¼"D
WHITE
862-002-035



WASTE PULL-OUT

DBL 50 QT SOFT CLOSE
MINIMUM OPENING
15"W X 23¼"H X 22¼"D
WHITE
861-021-153



DOOR MOUNT KIT

REQUIRED FOR THE TWO PULL-OUTS
ABOVE IF YOU WANT TO MOUNT A DOOR.
862-002-045

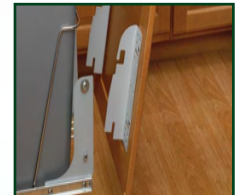

WASTE PULL-OUT

DBL 35 QT SOFT CLOSE
FINISHED MAPLE
SOFT-CLOSE BLUMOTION
MINIMUM OPENING
15"W X 20¾"H X 21¾"D
METALLIC SILVER
861-021-144



WASTE REPLACEMENT BIN

35 QT WHITE
862-002-055



Valencia
Lumber and Panel

15809 STRATHERN STREET • VAN NUYS CA • 91406

FUN FACT:
TREES GET 90% OF THEIR NUTRITION FROM THE
ATMOSPHERE AND ONLY 10% FROM THE SOIL.

818-786-5800

SALES@VALENCIALUMBER.COM

WWW.VALENCIALUMBER.COM



CABINET ORGANIZATION



WASTE PULL-OUT

DBL 36 QT SOFT CLOSE
CHAMPAGNE FINISH
W/GREY BINS
MINIMUM OPENING
15½"W X 19½"H X 22½"D
861-025-163



WASTE PULL-OUT

DBL 36 QT SOFT CLOSE
CHROME FINISH
W/WHITE BINS
MINIMUM OPENING
15½"W X 19½"H X 22½"D
861-025-150



WASTE PULL-OUT

SGL 36 QT SOFT CLOSE
CHAMPAGNE FINISH
W/GREY BINS
MINIMUM OPENING
12½"W X 19½"H X 22½"D
861-025-185



WASTE PULL-OUT

SGL 36 QT SOFT CLOSE
CHROME FINISH
W/WHITE BINS
MINIMUM OPENING
12½"W X 19½"H X 22½"D
861-025-199



SINK CADDY

CHROME FINISH
W/ GREY BINS
862-025-177



Valencia
Lumber and Panel

15809 STRATHERN STREET • VAN NUYS CA • 91406

*FUN FACT:
THE HARDNESS OF WOOD IS RATED BY THE "JANKA TEST".
THE TEST MEASURES THE FORCE REQUIRED TO EMBED A .444
INCH STEEL BALL INTO THE WOOD BY HALF ITS DIAMETER.*

818-786-5800

SALES@VALENCIALUMBER.COM

WWW.VALENCIALUMBER.COM



CLOSET & SHELVING

8' ROUND CHROME STEEL

1-1/16" DIAMETER 860-001-020
 1-5/16" DIAMETER 860-001-100

8' OVAL CHROME STEEL

15MM x 30MM 860-001-180

8' OVAL MATTE BLACK ALUMINUM

15MM x 30MM 860-001-260

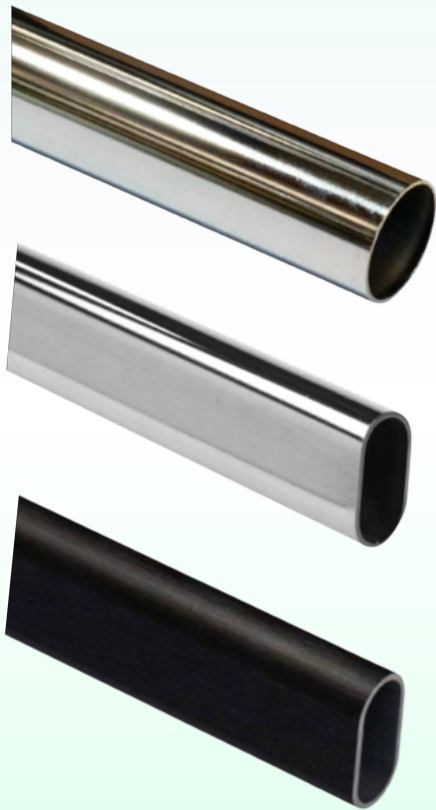

ROUND SUPPORTS

1-1/16" CLOSED 860-001-060
 1-1/16" OPEN 860-001-080
 1-1/16" CENTER 860-001-090

1-5/16" CLOSED 860-001-140
 1-5/16" OPEN 860-001-160
 1-5/16" CENTER 860-001-170



OVAL SUPPORTS

CHROME SCREW-ON SUPPORT 860-001-220
 CHROME DOWELED SUPPORT 860-001-240
 CHROME CENTER SUPPORT 860-001-250

BLACK SCREW-ON SUPPORT 860-001-270
 BLACK DOWELED SUPPORT 860-001-280
 BLACK CENTER SUPPORT 860-001-290



Valencia
Lumber and Panel

15809 STRATHERN STREET • VAN NUYS CA • 91406

☎ 818-786-5800

✉ SALES@VALENCIALUMBER.COM

🌐 WWW.VALENCIALUMBER.COM



CLOSET & SHELVING

PRE-CUT CLOSET, SHELVING, AND CABINET PARTS

WHITE MELAMINE

12" NO BORE	810-000-050
12" BORED 1 SIDE	810-000-100
16" NO BORE	810-000-125
16" BORED 1 SIDE	810-000-150
16" BORED 2 SIDES	810-000-160
24" NO BORE	810-000-175
24" BORED 1 SIDE	810-000-200

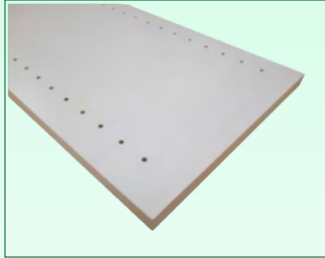

3/4" x 97"
BANDED ONE EDGE

HARD ROCK MAPLE MELAMINE

12" NO BORE	810-000-225
12" BORED 1 SIDE	810-000-250
16" NO BORE	810-000-275
16" BORED 1 SIDE	810-000-300
16" BORED 2 SIDES	810-000-310
24" NO BORE	810-000-325
24" BORED 1 SIDE	810-000-350

SPOON SHELF PINS

5MM CHROME

100 CT.	802-400-065
1000 CT.	802-400-070



ANGLE SHELF PINS

5MM CHROME

100 CT.	802-400-075
1000 CT.	802-400-080



DRAWER SIDES

PREFINISHED EURO-BIRCH • NO GROOVE
BULLNOSE & CLEAR FOIL BOTH EDGES

1/2" x 8-3/16" x 60"	801-500-250
1/2" x 11-5/8" x 60"	801-500-300



BACKERS & BOTTOMS

1/4" x 4' x 8' PANELS

WHITE MELAMINE 1S

212-701-000

HARD ROCK MAPLE VINYL/FOIL 1S

212-450-500

HARD ROCK MAPLE MELAMINE 2S

212-452-000

PREFINISHED BIRCH PLY 1S

221-220-500

PREFINISHED MAPLE PLY 1S

226-301-000

PREFINISHED MAPLE MDF 1S

226-301-750

PREFINISHED MAPLE (3/8") PLY 2S

226-302-200

MANY MORE CHOICES ALSO AVAILABLE INCLUDING WALNUT, RIFT AND PLAIN SAWN WHITE OAK, FINISHED TWO SIDES, MORE THICKNESSES AND SIZES.

PLEASE CONTACT OUR SALES DEPARTMENT FOR MORE INFO.



Valencia
Lumber and Panel

15809 STRATHERN STREET • VAN NUYS CA • 91406

818-786-5800

SALES@VALENCIALUMBER.COM

WWW.VALENCIALUMBER.COM



SLIDES & HINGES

DRAWER SLIDES 2D QUADRO SOFT-CLOSE

- 9" 812-121-005
- 12" 812-121-022
- 15" 812-121-041
- 18" 812-121-067
- 21" 812-121-085
- 24" 812-121-097



**UNDERMOUNT DRAWER SLIDE
PUSH-TO-OPEN OPTION
90 LB CAPACITY
SILENT SYSTEM**

1D DRAWER CLIPS

VERTICAL ADJUSTMENT ONLY

1/2" DRAWER SIDES 812-121-250



PUSH-TO-OPEN SYSTEM

FOR 12"- 24" SLIDES • 15-45 LB LOAD

812-121-125



2D DRAWER CLIPS

VERTICAL & HORIZONTAL ADJUSTMENT

1/2" DRAWER SIDES 812-121-256

5/8" DRAWER SIDES 812-121-272



PUSH-TO-OPEN CLICKS ONTO THE 2D DRAWER SLIDE IN ONLY SECONDS. ADD THE SYNC-BAR FOR EFFORTLESS, SMOOTH OPERATION PROVIDING SYNCHRONIZATION BETWEEN THE LEFT & RIGHT COMPONENTS SO A PUSH ANYWHERE ON FRONT WILL TRIGGER THE OPERATION.

REAR BRACKET

FOR FACE-FRAME APPLICATIONS

812-121-287



PUSH-TO-OPEN SYNC-BAR

78¾" LENGTH

812-120-287



Valencia
Lumber and Panel

15809 STRATHERN STREET • VAN NUYS CA • 91406

☎ 818-786-5800

✉ SALES@VALENCIALUMBER.COM

🌐 WWW.VALENCIALUMBER.COM



SLIDES & HINGES



SENSYS SILENT SYSTEM SOFT-CLOSE HINGES

FULL-OVERLAY 110°

SCREW-ON 812-220-005
PRESS-IN 812-220-011
TOOL-LESS 812-220-015
EXPANDING 812-220-002



INSET 95°

THICK DOOR HINGE
PRESS-IN 812-220-022



HALF-OVERLAY 110°

SCREW-ON 812-220-007
PRESS-IN 812-220-012
TOOL-LESS 812-220-017



FULL-OVERLAY 165°

PRESS-IN 812-220-031



INSET 110°

SCREW-ON 812-220-010
PRESS-IN 812-220-013
TOOL-LESS 812-220-020
EXPANDING 812-220-004



HALF-OVERLAY 165°

PRESS-IN 812-220-032
TOOL-LESS 812-220-034



FULL-OVERLAY 95°

THICK DOOR HINGE
PRESS-IN 812-220-021



FUN FACT:

WET WOOD, UNLIKE DRY WOOD,
CAN CONDUCT ELECTRICITY.



Valencia
Lumber and Panel

15809 STRATHERN STREET • VAN NUYS CA • 91406



818-786-5800



SALES@VALENCIALUMBER.COM



WWW.VALENCIALUMBER.COM



SLIDES & HINGES



SENSYS SILENT SYSTEM SOFT-CLOSE HINGES

BLIND CORNER

INSET 90°
TOOL-LESS
812-220-039



30° ANGLED

FULL-OVERLAY 95°
TOOL-LESS
812-220-048
EXPANDING
812-220-049



LAZY SUSAN

TOOL-LESS
812-220-028



30° ANGLED

INSET 95°
PRESS-IN
812-220-046



45° ANGLED

FULL-OVERLAY 95°
TOOL-LESS
812-220-053



45° ANGLED

INSET 95°
TOOL-LESS
812-220-054

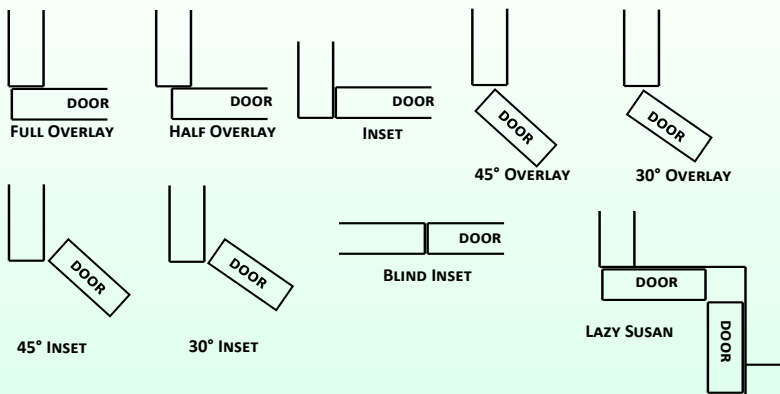

Valencia
Lumber and Panel

15809 STRATHERN STREET • VAN NUYS CA • 91406



818-786-5800



SALES@VALENCIALUMBER.COM



WWW.VALENCIALUMBER.COM



SLIDES & HINGES



SENSYS HINGE PLATES

SCREW-ON

- 0 MM 812-220-084
- 3 MM 812-220-085



UNIVERSAL FACE-FRAME

WITH CAM

- 0 MM 812-220-071
- 4.5 MM 812-220-072



EXPANDING

- 0 MM 812-220-082
- 3 MM 812-220-083
- 5 MM 812-220-091



FACE-FRAME

- 0 MM 812-220-065
- 4.5 MM 812-220-070



EURO-SCREW

- 0 MM 812-220-075
- 3 MM 812-220-080
- 5 MM 812-220-108
- 9.5 MM 812-220-566



NO SCREW

- 3 MM 812-220-087



PRESS-IN

- 9 MM 812-220-571



FACE-FRAME INSET

- 3 MM 812-220-073



Valencia
Lumber and Panel

15809 STRATHERN STREET • VAN NUYS CA • 91406



818-786-5800



SALES@VALENCIALUMBER.COM



WWW.VALENCIALUMBER.COM



*FUN FACT:
IT'S ESTIMATED THAT ON AVERAGE,
EACH AMERICAN USES 40 POUNDS
OF GLUE PER YEAR.*

DECKING STUFF

TRIM HEAD DECK SCREWS

T-15 TORX DRIVE
TYPE 17 POINT FOR WOOD JOIST
#8 X 2" STAINLESS STEEL



- STAINLESS 100 CT. 802-725-007
- STAINLESS 350 CT. 802-726-003
- STAINLESS 1050 CT. 802-726-022
- BLACK 100 CT. 802-725-015
- BLACK 350 CT. 802-726-014
- BLACK 1050 CT. 802-726-035

IPE CLIP EXTREME HIDDEN DECK FASTENERS

- 3/32" GAP 175 CT. 802-710-004
- 3/32" GAP 525 CT. 802-715-005
- 3/32" GAP 1050 CT. 802-720-006
- 5/32" GAP 175 CT. 802-720-070
- 5/32" GAP 525 CT. 802-720-075
- 5/32" GAP 1050 CT. 802-720-080



EACH KIT CONTAINS:

- FASTENERS ▪IPE PLUGS
- DECK SCREWS ▪DECK SPACERS
- T-15 TORX DRIVE TIP▪DRILL BITS

JOIST TAPE

WISE WRAP SELF ADHESIVE BUTYL

- 1-5/8" x 50' 802-764-018
- 3-1/8" x 50' 802-765-024



METAL JOIST DECK SCREWS

T-15 TORX DRIVE
SELF TAPPING FOR METAL JOIST
#8 X 1 1/8" STAINLESS STEEL



- STAINLESS 100 CT. 802-726-050
- STAINLESS 350 CT. 802-726-080
- STAINLESS 1050 CT. 802-726-110
- BLACK 100 CT. 802-725-060
- BLACK 350 CT. 802-726-090
- BLACK 1050 CT. 802-726-120

WISE-GUIDES DECK BOARD SPACERS

- 1/8" GAP 6 CT. 802-750-005
- 1/8" GAP 20 CT. 802-750-035
- 5/32" GAP 6 CT. 802-750-012
- 5/32" GAP 20 CT. 802-750-042



IPE PLUGS 3/8"

- 100 CT. 802-731-002
- 350 CT. 802-734-010
- 1050 CT. 802-734-020



RED BALAU PLUGS 3/8"

(MANGARIS)
100 CT. 802-731-003

AND THE PERFECT CHOICE
FOR GLUING THOSE PLUGS...

GORILLA GLUE

POLYURETHANE GLUE
4 OUNCE 840-765-006



Valencia
Lumber and Panel

15809 STRATHERN STREET • VAN NUYS CA • 91406



818-786-5800



SALES@VALENCIALUMBER.COM



WWW.VALENCIALUMBER.COM



DECKING STUFF

DRILL & DRIVE SET
802-505-025

5 PACK REPLACEMENT BIT WITH COUNTERSINK
802-760-030

10 PACK 1/8" BITS ONLY
802-760-043

IF YOU'RE DRILLING IPE OR TEAK YOU'LL WANT TO STOCK UP ON THESE REPLACEMENT BITS.



PLUG CUTTER 3/8"

ANTI-SKATE DESIGNED TIP FOR ON THE JOB USE WITH A HAND DRILL
802-760-137



MORE PLUG CUTTERS ON PAGE 96

HARDWOOD WRENCH
DECK & SIDING STRAIGHTENING TOOL
802-740-100

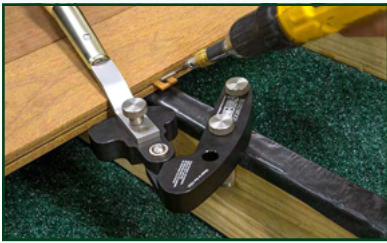

IPE OIL
WOOD DECK FINISH
OIL BASE
GALLON 802-764-005



IPE SEAL
END GRAIN SEALER
WAX EMULSION
QUART 802-764-066



SLOTING CUTTER
5/32" (4 MM) KERF
1/2" SHANK
820-001-397



MORE SLOTTING CUTTERS ON PAGE 92

WISECOAT
SIDING & FENCE SEALER
WATER BASE
GALLON 802-764-090



MORE EXTERIOR FINISHES ON PAGES 69 & 70

T-15 TORX BIT
10 PACK

1" 802-760-311
2" 802-760-315



DECK MAINTENANCE 32 OZ
DECK CLEANER 802-764-044
DECK BRIGHTENER 802-764-051



DeckWise
An Ipe Clip® Brand



Valencia
Lumber and Panel

15809 STRATHERN STREET • VAN NUYS CA • 91406

818-786-5800

SALES@VALENCIALUMBER.COM

WWW.VALENCIALUMBER.COM



MISCELLANEOUS

POCKET CHISEL SET

802-121-500

OR SOLD SEPARATELY

- 1/4" CHISEL 802-121-485
- 1/2" CHISEL 802-121-480
- 3/4" CHISEL 802-121-190
- 1" CHISEL 802-121-475
- SHARPENER 802-121-495
- PUTTY KNIFE 802-121-785



HANDLE ON DEMAND

HIGH PERFORMANCE SUCTION HANDLE
802-120-855



CUSTOM COLOR PUNCH KIT

CAN'T FIND THE RIGHT SCREW CAP COLOR?
MAKE YOUR OWN CUSTOM SCREW CAPS WITH THE FAST-CAP
PUNCH KIT USING YOUR OWN EDGE-BANDING.
802-120-870



SKINS GLOVES

- SMALL 802-122-200
- MEDIUM 802-122-195
- LARGE 802-122-180
- X LARGE 802-122-205

FLUSH CUT TRIMMER

- STANDARD 802-121-715
- HEAVY DUTY 802-121-720



SPEED ROLLER PRO

802-122-265
STEEL & RUBBER ROLLERS INCLUDED

3RD HAND FAMILY

- LITTLE HAND 16"-22" 802-119-715
- UPPER HAND 28"-60" 802-119-785
- HD TWIN PACK 60"-144" 802-119-635
- HD CONTRACTOR 4 PACK 802-119-670

THE 3RD HAND HD IS THE HELP YOU HAVE BEEN LOOKING FOR. IF YOU EVER WISHED YOU HAD AN EXTRA HAND, LOOK NO FURTHER. IT IS RUGGED, BUILT TO LAST A LIFETIME AND IT'S NEVER LATE FOR WORK! BRACE, JACK, OR SUPPORT WHATEVER YOU NEED.

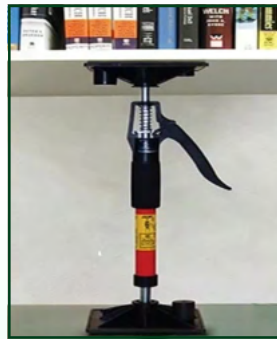

TAPE MEASURES

- 16' STANDARD 802-121-835
- 16' METRIC 802-121-750
- 16' AUTO-LOCK 802-121-755
- 16' FLATBACK 802-121-765
- 25' STANDARD 802-121-840
- 25' METRIC 802-121-760



SPEED CLIP

TAPE MEASURE
BELT CLIP
802-122-260



Valencia
Lumber and Panel

15809 STRATHERN STREET • VAN NUYS CA • 91406



818-786-5800



SALES@VALENCIALUMBER.COM



WWW.VALENCIALUMBER.COM



MISCELLANEOUS

SHELF PINS

5 MM CHROME SPOON
100 CT. 802-400-065
1000 CT. 802-400-070



SHELF PINS

5 MM CHROME ANGLE
100 CT. 802-400-075
1000 CT. 802-400-080



FLOATING SHELF BRACKETS

200 LBS PER PAIR
 EASY ADJUST TO LEVEL
8" PAIR 802-410-040



BUMPER PADS

5/64" x 5/16" x 450
 802-320-800



BISCUITS

#20 1000/Box
 802-320-810



CHIP BRUSH

8 PACK OF 1 1/2" - 3"
 700-200-090



FOAM BRUSH

9 PACK OF 1" - 3"
 700-200-131



SAFETY GLASSES

CLEAR WRAP AROUNDS
 802-122-210



PUTTY KNIFE

1 1/4" FLEXIBLE
 802-121-930



ALL PURPOSE 10" FILE

802-121-915



WOOD SHIMS

8" PINE
 120/BOX
 802-320-010



FURNITURE PAD

72" x 80"
 802-150-050



RATCHET STRAPS

2 PACK 15' LENGTH
 802-124-015

RATCHET STRAPS AREN'T JUST FOR SECURING CARGO. THEY'RE ALSO GREAT IN THE SHOP AS WEB CLAMPS FOR CLAMPING FRAMES, CYLINDERS, IRREGULAR SHAPES, ETC.

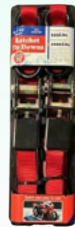

STRETCH WRAP

3" 802-124-015
 5" 802-310-025
 18" 802-310-035
 HANDLE 802-310-090



THE STUD BUDDY

MAGNETIC STUD FINDER
 802-121-918



UTILITY KNIFE

BREAK-AWAY
 802-122-370



REFILLS

10 PACK
 802-122-380

BRAD POINT BITS

2 MM (5 PACK) 820-002-610
 1/8" (5 PACK) 820-002-615
 3/16" (5 PACK) 820-002-625
 5 MM (5 PACK) 820-002-635
 1/4" (5 PACK) 820-002-645
 5/16" (5 PACK) 820-002-650
 3/8" (1 EACH) 820-002-660
 7/16" (1 EACH) 820-002-670
 1/2" (1 EACH) 820-002-680
 16 MM* (1 EACH) 820-002-683



* 10" LENGTH FOR FLOATING SHELF BRACKETS

TAPER BITS

W/ 3/8" COUNTERSINK
 1/4" QUICK-CHANGE DRIVE

#4 (2 PACK) 820-002-684
 #6 (2 PACK) 820-002-690
 #6 (6 PACK) 820-002-685
 #8 (2 PACK) 820-002-705
 #10 (2 PACK) 820-002-715



SELF-CENTERING BITS

3 PACK
 7/64" • 9/64" • 11/64"
 802-002-719



5/16" PRO PLUG

SYSTEM FOR WOOD
 802-760-035



STARBORN

FORSTNER BITS, STEP BITS,
 BORING BITS, AND PLUG
 CUTTERS ON PAGE 96



Valencia
Lumber and Panel

15809 STRATHERN STREET • VAN NUYS CA • 91406



818-786-5800



SALES@VALENCIALUMBER.COM



WWW.VALENCIALUMBER.COM



CMT ORANGE TOOLS

—INDUSTRIAL GRADE BLADES—

FULL KERF



RIPPING

+20° Hook FTG

10" x 24T 5/8" BORE 820-001-703

12" x 30T 1" BORE 820-001-704

FOR FAST, SMOOTH, EFFORTLESS RIPPING



COMBINATION

+12° Hook 20° ATB+1TCG

10" x 50T 5/8" BORE 820-001-755

FOR CLEAN RIPPING & CROSSCUTS



FINE FINISH

+5° Hook 20° ATB

10" x 60T 5/8" BORE 820-001-758

SMOOTH CROSSCUTS. ALSO GREAT FOR PLYWOOD



ULTRA FINE FINISH

+2° Hook 38° HI-ATB

8-8 1/4" x 60T 5/8" BORE 820-001-706

10" x 80T 5/8" BORE 820-001-747

12" x 96T 1" BORE 820-001-749

FOR ULTRA FINE FINISH ON MELAMINE, LAMINATES, AND VENEERED PANELS



ULTRA FINE FINISH

-5° Hook 30° ATB+1TCG

8 1/2" x 60T 5/8" BORE 820-001-714

10" x 80T 5/8" BORE 820-001-725

12" x 90T 1" BORE 820-001-736

FOR ULTRA FINE FINISH ON SLIDING COMPOUND MITER SAWS

THIN KERF



ULTRA FINISH

+5° Hook 30° HI-ATB

10" x 80T 5/8" BORE 820-001-955



NON-FERROUS

-6° Hook TCG

10" x 80T 5/8" BORE 820-001-879

GREAT FOR COMPOSITE DECKING



FRAMING/DECKING

8-8 1/4" x 24T ATB

5/8" BORE W/KNOCK-OUT

820-001-709



FINISH

8-8 1/4" x 40T ATB

5/8" BORE W/KNOCK-OUT

820-001-707

8" DADO PRO

1/4" - 13/16" WIDE DADOS
820-001-901



2 BLADES



3 CHIPPERS



8 SHIMS

—PANEL SAWS—

PANEL SIZING

INDUSTRIAL GRADE

3.2MM KERF ▪ +5° HOOK ▪ TCG

30MM BORE

PIN 2/10/60 + 2/7/42

300mm x 96T 820-001-740



MELAMINE & PLY

INDUSTRIAL GRADE

3.2MM KERF ▪ +2° HOOK ▪ 38° HI-ATB

30MM BORE

PIN 2/7/42 + 2/9.5/46.5 + 2/10/60

300mm x 96T 820-001-742



Valencia

Lumber and Panel

15809 STRATHERN STREET • VAN NUYS CA • 91406



818-786-5800



SALES@VALENCIALUMBER.COM



WWW.VALENCIALUMBER.COM



CMT ORANGE TOOLS

CONTRACTOR GRADE BLADES



RIPPING
10" X 24T 5/8 BORE
820-001-791



GENERAL PURPOSE
10" X 40T 5/8 BORE
820-001-802
12" X 40T 1" BORE
820-001-813



FINISH
10" X 60T 5/8 BORE
820-001-824
12" X 60T 1" BORE
820-001-835



FINE FINISH
10" X 80T 5/8 BORE
820-001-769
12" X 80T 1" BORE
820-001-775

7 1/4" CONTRACTOR GRADE BLADES



FRAMING/DECKING
7 1/4" X 24T
820-001-846
JOB PACK OF 10
820-001-849



FINISH
7 1/4" X 40T
820-001-857
JOB PACK OF 10
820-001-859

7 1/4" INDUSTRIAL GRADE BLADES



ULTRA FINISH
7 1/4" X 60T
820-001-868



ZERO-GRAVITY FRAMING
7 1/4" X 24T
820-001-850



ZERO-GRAVITY FINISH
7 1/4" X 40T
820-001-860



ZERO-GRAVITY DEMOLITION
7 1/4" X 24T
820-001-705
CUT THRU NAILS AND OTHER EMBEDDED MATERIALS WITH EASE AND CONFIDENCE

ZERO-GRAVITY BLADES ARE SPECIALLY DESIGNED FOR CORDLESS SAWS. LESS MASS AND WEIGHT MEANS MORE BATTERY LIFE AND PROFIT.

6 1/2" INDUSTRIAL GRADE BLADES



FAST FRAMING
6 1/2" X 18T ATB
820-001-716



FINISH
6 1/2" X 36T ATB
820-001-717



BISCUIT JOINER
4" (200MM) X 8T 20MM BORE
820-001-901

6 1/2" TRACK SAW

GENERAL PURPOSE
6 1/2" X 24T ATB
20MM BORE
820-001-718



ULTRA FINE
6 1/2" X 56T ATB
20MM BORE
820-001-720



160MM FESTOOL

GENERAL PURPOSE
160MM X 24T ATB
20MM BORE
820-001-721

ULTRA FINE
160MM X 56T ATB
20MM BORE
820-001-723



Valencia
Lumber and Panel

15809 STRATHERN STREET • VAN NUYS CA • 91406



818-786-5800



SALES@VALENCIALUMBER.COM



WWW.VALENCIALUMBER.COM



CMT ORANGE TOOLS

JIGSAW BLADES

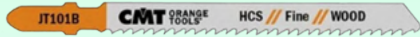

FINE FOR STRAIGHT CUTS
5 PACK 820-001-912



FINE FOR CURVED CUTS
5 PACK 820-001-923



COARSE FOR STRAIGHT CUTS
5 PACK 820-001-934

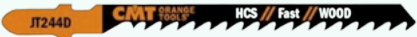

COARSE FOR CURVED CUTS
5 PACK 820-001-945

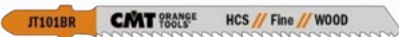

FINE REVERSE TOOTH
5 PACK 820-001-967



METAL CUTTING
5 PACK 820-001-956

16 PIECE SET
820-001-978

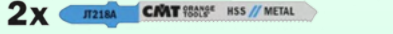
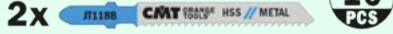
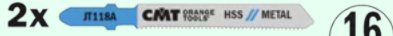
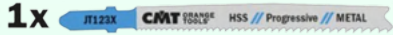

16
PCS

RECIPROCATATING BLADES



8" FINE WOOD 5 PACK 820-002-132



9" FLEX WOOD/METAL 5 PACK 820-002-143



9" FLEX METAL 5 PACK 820-002-154

25 PIECE SET 820-002-165



PLANER BLADES

SOLID CARBIDE SET OF 2
82MM X 5.5MM X 1.1MM
820-001-697



CARBIDE TIPPED SET OF 2
82MM X 29MM X 3MM
820-001-699



Valencia
Lumber and Panel

15809 STRATHERN STREET • VAN NUYS CA • 91406

818-786-5800

SALES@VALENCIALUMBER.COM

WWW.VALENCIALUMBER.COM



CMT ORANGE TOOLS

OSCILLATING MULTI-TOOL

1-3/8" PLUNGE/FLUSH CUT

FOR WOOD 5 PACK
820-001-989

STARLOCK



DELTA SANDING PAD

3 5/8"
820-002-123

STARLOCK



1-3/16" PLUNGE/FLUSH CUT

FOR METAL 5 PACK
820-002-022

STARLOCK



2-1/16" FLEX SCRAPER

1 PACK
820-002-066

STARLOCK



DELTA PAD SANDPAPER

10 PACK

80 GRIT 820-002-124
100 GRIT 820-002-125
120 GRIT 820-002-126
180 GRIT 820-002-127



4 PIECE SET

820-002-121

STARLOCK



SET INCLUDES ONE EACH:
1-3/8" JAPANESE PRECISION CUT
2-9/16" JAPANESE PRECISION CUT
1-3/8" PLUNGE & FLUSH
2" PLUNGE & FLUSH



Valencia
Lumber and Panel

15809 STRATHERN STREET • VAN NUYS CA • 91406

818-786-5800

SALES@VALENCIALUMBER.COM

WWW.VALENCIALUMBER.COM



CMT ORANGE TOOLS

INDUSTRIAL GRADE
CARBIDE TIPPED ROUTER BIT
STRAIGHT CUTTERS



- 1/8" D 1/4" SHANK 820-001-021
- 1/4" D 1/4" SHANK 820-001-043
- 3/8" D 1/4" SHANK 820-001-065
- 1/2" D 1/2" SHANK 820-001-076
- 3/4" D 1/2" SHANK 820-001-098
- 1" D 1/2" SHANK 820-001-109

CONTRACTOR GRADE
CARBIDE TIPPED ROUTER BIT
STRAIGHT CUTTERS
5 PC. SET
1/4" SHANKS
820-001-115



1/8" 1/4" 3/8" 1/2" 3/4"

INDUSTRIAL GRADE
CARBIDE TIPPED ROUTER BIT
V-GROOVE



90° 1/4" SHANK 820-001-670

INDUSTRIAL GRADE
CARBIDE TIPPED ROUTER BIT
ROUND OVERS



- 1/16" R 1/4" SHANK 820-001-120
- 1/8" R 1/4" SHANK 820-001-131
- 1/4" R 1/4" SHANK 820-001-142
- 3/8" R 1/4" SHANK 820-001-153
- 1/2" R 1/2" SHANK 820-001-164
- 5/8" R 1/2" SHANK 820-001-175
- 3/4" R 1/2" SHANK 820-001-186
- 7/8" R 1/2" SHANK 820-001-197
- 1" R 1/2" SHANK 820-001-208

CONTRACTOR GRADE
CARBIDE TIPPED ROUTER BIT
ROUND OVERS
4 PC. SET
1/4" SHANKS
820-001-217



1/8" 1/4" 3/8" 1/2"

INDUSTRIAL GRADE
SOLID CARBIDE
LASER POINT LETTERING

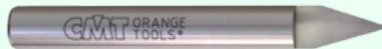

35° 1/4" SHANK 820-001-615

INDUSTRIAL GRADE
CARBIDE TIPPED ROUTER BIT
BEADING



- 1/4" R 1/4" SHANK 820-001-340
- 3/8" R 1/4" SHANK 820-001-351
- 1/2" R 1/2" SHANK 820-001-362

INDUSTRIAL GRADE
CARBIDE TIPPED ROUTER BIT
ROUND NOSE



- 1/8" D 1/4" SHANK 820-001-219
- 1/4" D 1/4" SHANK 820-001-230
- 1/2" D 1/2" SHANK 820-001-252
- 3/4" D 1/2" SHANK 820-001-274
- 1" D 1/2" SHANK 820-001-285

INDUSTRIAL GRADE
CARBIDE TIPPED ROUTER BIT
COVE



- 1/4" R 1/4" SHANK 820-001-296
- 3/8" R 1/4" SHANK 820-001-307
- 1/2" R 1/2" SHANK 820-001-318

WE WELCOME SPECIAL ORDERS.
PLEASE CONTACT OUR SALES
DEPARTMENT FOR DETAILS.



Valencia
Lumber and Panel

15809 STRATHERN STREET • VAN NUYS CA • 91406



818-786-5800



SALES@VALENCIALUMBER.COM



WWW.VALENCIALUMBER.COM



CMT ORANGE TOOLS

INDUSTRIAL GRADE
CARBIDE TIPPED ROUTER BIT
CHAMFER



45° BEVEL 1/2" SHANK
1" CUTTING DEPTH, 2-9/16" DIAMETER
820-001-615

CONTRACTOR GRADE
CARBIDE TIPPED ROUTER BIT
CHAMFER



45° BEVEL 1/4" SHANK
7/16" CUTTING DEPTH, 1-3/8" DIAMETER
820-001-611

INDUSTRIAL GRADE
CARBIDE TIPPED ROUTER BIT
RABBET



3/8" RABBET 1/4" SHANK
820-001-637

INDUSTRIAL GRADE
SOLID CARBIDE
SPIRAL FLUSH TRIM



1/4" DIAMETER DOWNCUT
1" DEPTH OF CUT
820-001-538

INDUSTRIAL GRADE
CARBIDE TIPPED ROUTER BIT
FLUSH TRIM



1/2" DIAMETER, 1" DEPTH OF CUT
1/4" SHANK
820-001-527



3/4" DIAMETER, 1 1/2" DEPTH OF CUT
1/2" SHANK
820-001-582

INDUSTRIAL GRADE
CARBIDE TIPPED ROUTER BIT
PATTERN

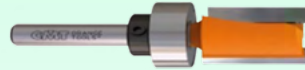

1/2" DIAMETER, 3/4" DEPTH OF CUT
1/4" SHANK
820-001-571



1/2" DIAMETER, 1 1/4" DEPTH OF CUT
1/4" SHANK
820-001-573



3/4" DIAMETER, 1 1/2" DEPTH OF CUT
1/2" SHANK
820-001-575

INDUSTRIAL GRADE
CARBIDE TIPPED ROUTER BIT
BEVEL TRIM



15° 1/4" SHANK
820-001-560

THE GRAND RABBET

820-001-692



THE GRAND RABBET BY CMT IS AN INVESTMENT THAT SHOWS YOUR COMMITMENT TO QUALITY. THIS CMT PRODUCT WILL DELIVER YEARS OF RELIABLE SERVICE UNDER NORMAL USE.

THE KIT WILL ENABLE YOU TO PRODUCE 17 DIFFERENT RABBET SIZES INCLUDING RABBETS FOR UNDER-SIZED PLYWOOD APPLICATIONS.



Valencia
Lumber and Panel

15809 STRATHERN STREET • VAN NUYS CA • 91406

818-786-5800

SALES@VALENCIALUMBER.COM

WWW.VALENCIALUMBER.COM



CMT ORANGE TOOLS

INDUSTRIAL GRADE
CARBIDE TIPPED ROUTER BIT
SLOTING CUTTERS

WITH 1/2" SHANK ARBOR & BEARING

- 1/8" KERF 820-001-386
- 5/32" KERF 820-001-397
- 1/4" KERF 820-001-419



INDUSTRIAL GRADE
CARBIDE TIPPED
SLOTING CUTTERS
WINGS ONLY

- 1/16" KERF 820-001-373
- 1/8" KERF 820-001-384
- 5/32" KERF 820-001-395
- 3/16" KERF 820-001-406
- 1/4" KERF 820-001-417



- ARBOR WITH BEARING**
- 1/4" SHANK 820-001-439
 - 1/2" SHANK 820-001-428



SLOTING CUTTER SET
820-001-450



CREATE SLOTS, GROOVES AND RABBETS EASILY WITH THESE CMT SLOT CUTTERS SETS. IDEAL FOR BISCUIT JOINTS AND MILLING PERFECT T&G JOINTS, THESE SETS INCLUDE 4 BEARINGS ALLOWING DIFFERENT CUTTING DEPTHS: 5/16", 3/8", 1/2", 9/16".

SPOILBOARD/SURFACING

- 2" CUTTING DIAMETER
- 1/2" CUTTING DEPTH
- 2 1/2" OVERALL HEIGHT
- 1/2" SHANK
- 820-001-117



GLUE JOINT BIT
19/32" - 1-3/16"
THICKNESSES
1/2" SHANK
820-001-593

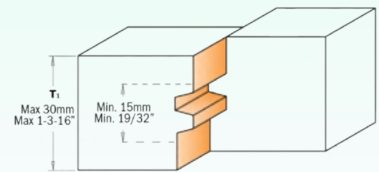

THE MOST UNIQUE AND IMPORTANT CHARACTERISTIC OF THIS CMT BIT IS ITS CAPACITY TO PRODUCE A VIRTUALLY INDESTRUCTIBLE GLUE JOINT QUICKLY AND FLAWLESSLY. IDEAL FOR ROUTING PANELS, DOORS AND FURNITURE PIECES OF WIDE DIMENSION, PANELS, DOORS AND FURNITURE PIECES. SIMPLY RUN ONE EDGE OF THE PANEL, TURN THE PANEL OVER, AND THEN RUN THE OPPOSITE EDGE - YOU WILL CRAFT PERFECTLY HARMONIZED REVERSE CUTS THAT MATCH-UP TO PRODUCE IMMACULATE JOINTS!

LOCK MITER BIT
19/32" - 1-1/8"
THICKNESSES
45° BEVEL
1/2" SHANK
820-001-604



Valencia
Lumber and Panel

15809 STRATHERN STREET • VAN NUYS CA • 91406

818-786-5800

SALES@VALENCIALUMBER.COM

WWW.VALENCIALUMBER.COM



CMT ORANGE TOOLS

INDUSTRIAL GRADE
CARBIDE TIPPED ROUTER BIT

OGEE

5/32" R 1/4" SHANK 820-001-505
1/4" R 1/2" SHANK 820-001-516

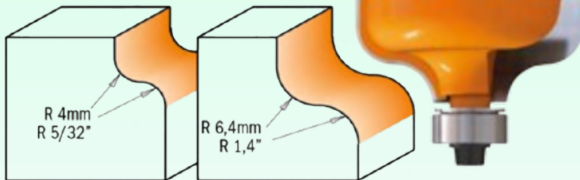

MULTI-PROFILE BIT

2-3/16" DIAMETER
1-7/8" CUTTING HEIGHT
3-3/4" OVERALL HEIGHT
1/2" SHANK
820-001-626



INDUSTRIAL GRADE
CARBIDE TIPPED ROUTER BIT

ROMAN OGEE

5/32" R 1/4" SHANK 820-001-461
1/4" R 1/2" SHANK 820-001-472

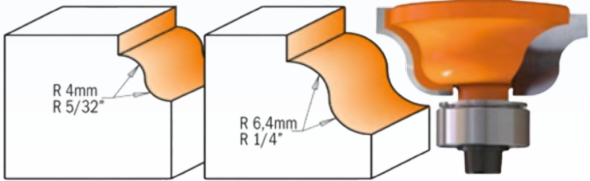

CNC ROUTER BITS SOLID CARBIDE

COMPRESSION

2 FLUTE DLCS CHROME COATED



3/8" x 3" 820-001-685
1/2" x 3" 820-001-687



3X
LONGER LIFE
THAN UNCOATED

DOWN-CUT

2 FLUTE DLCS CHROME COATED



3/8" x 3/4" 820-001-686



DLCS CHROME COATING
PROVIDES 3 TIMES LONGER LIFE THAN UNCOATED TOOLS

INDUSTRIAL GRADE
CARBIDE TIPPED ROUTER BIT

CLASSIC OGEE

5/32" R 1/4" SHANK 820-001-483
1/4" R 1/2" SHANK 820-001-494

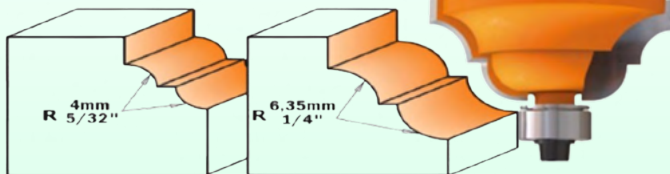

COMPRESSION 2 FLUTE



1/4" x 2 1/2" 820-002-577

DOWN-CUT 2 FLUTE



1/8" x 2" 820-001-694
1/4" x 2 1/2" 820-001-691
1/2" x 3" 820-001-689



Valencia
Lumber and Panel

15809 STRATHERN STREET • VAN NUYS CA • 91406

818-786-5800

SALES@VALENCIALUMBER.COM

WWW.VALENCIALUMBER.COM



CMT ORANGE TOOLS

**V-GROOVE
T&G SET**
3/4" - 1"
THICKNESSES
1/2" SHANK
820-001-681

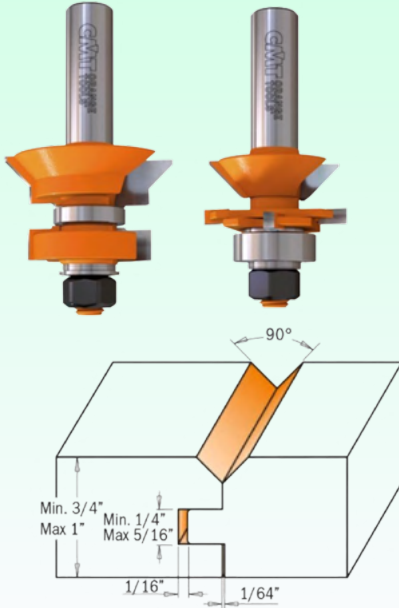

3 PIECE CABINET DOOR SET
STILE, RAIL, & RAISED PANEL
1/2" SHANK
820-001-661



**SQUARE EDGE
T&G SET**
1/2" - 1-1/4"
THICKNESSES
1/2" SHANK
820-001-659

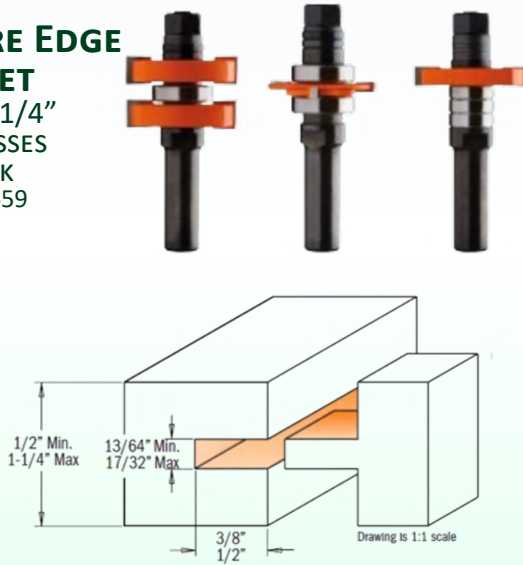

ROUTER BIT BUSHING SET
820-001-010



QTY	1	1	1	1	1	1	1	2	1
Internal diameter	5/8"	21/32"	17/32"	13/32"	11/32"	9/32"	1/4"	Lock Nut	Adapter
Outside diameter	51/64"	3/4"	5/8"	1/2"	7/16"	3/8"	5/16"	Lock Nut	
Height	9/16"	9/16"	9/16"	5/16"	5/32"	5/16"	5/32"		

MAKE YOUR OWN SHAKER STYLE CABINET DOORS WITH PRECISION.

- ADJUSTABLE AT 0.050MM (0.002") INCREMENTS.
- FOR GROOVE WIDTH FROM 5MM (13/64") TO 13.5MM (17/32").
- CUT STOCK THICKNESS FROM 12.7MM (1/2") TO 31.7MM (1-1/4").

INLAY BUSHING SET
820-001-011



A PERFECT FIT EVERY TIME



Valencia
Lumber and Panel

15809 STRATHERN STREET • VAN NUYS CA • 91406

818-786-5800

SALES@VALENCIALUMBER.COM

WWW.VALENCIALUMBER.COM



CMT ORANGE TOOLS

1 PC. STILE & RAIL CUTTER HEAD

1 1/4" BORE • 4.7" DIAM
HARD ALUMINUM ALLOY BODY
SOLID CARBIDE INSERT CUTTERS
820-002-435

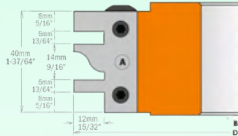
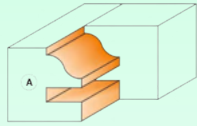

RAISED PANEL CUTTER HEAD

1 1/4" BORE • 7.2" DIAM
HARD ALUMINUM ALLOY BODY
SOLID CARBIDE INSERT CUTTERS
820-002-433

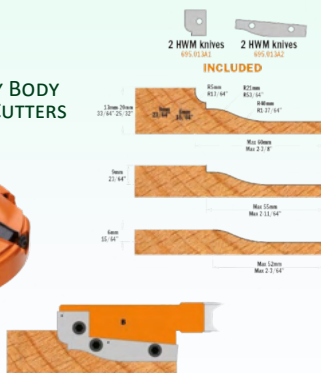

RABBETING CUTTER HEAD

1 1/4" BORE • 3.9" DIAM
2" CUTTING HEIGHT
HARD ALUMINUM ALLOY BODY
SOLID CARBIDE INSERT CUTTERS
820-002-431



REPLACEMENT INSERT KNIFE
12.5 x 50MM 820-002-518
12 x 14MM 820-002-519

REVERSE GLUE JOINT CUTTER HEAD

1 1/4" BORE • 3.9" DIAM
HARD ALUMINUM ALLOY BODY
SOLID CARBIDE INSERT CUTTERS
820-002-433

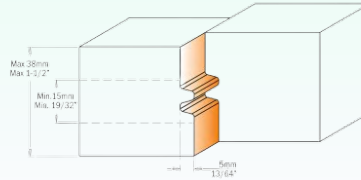

45° CHAMFER CUTTER HEAD

1 1/4" BORE • 5.9" DIAM
HARD ALUMINUM ALLOY BODY
SOLID CARBIDE INSERT CUTTERS
820-002-430



3 PC. ADJUSTABLE GROOVING SET CUTTER HEAD

1 1/4" BORE • 5.5" DIAM
STEEL BODY
SOLID CARBIDE INSERT CUTTERS
820-002-432

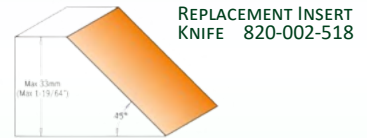
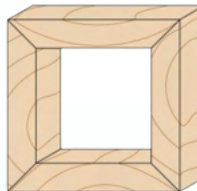
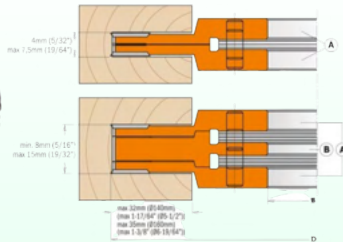

REPLACEMENT INSERT KNIFE 820-002-518

45° LOCK MITER CUTTER HEAD

1 1/4" BORE • 5.5" DIAM
HARD ALUMINUM ALLOY BODY
SOLID CARBIDE INSERT CUTTERS
820-002-434

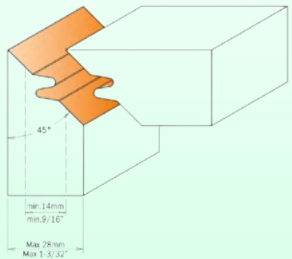
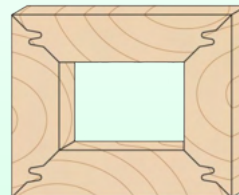

BORE REDUCERS FOR CUTTER HEADS

1 1/4" TO 3/4" 820-002-579
1 1/4" TO 1" 820-002-578

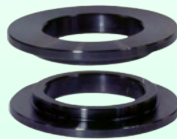

Valencia
Lumber and Panel

15809 STRATHERN STREET • VAN NUYS CA • 91406

818-786-5800

SALES@VALENCIALUMBER.COM

WWW.VALENCIALUMBER.COM



CMT ORANGE TOOLS

FORSTNER BITS

STANDARD RIM UNDER 1" DIAMETER
TOOTHED RIM OVER 1" DIAMETER
3/8" SHANK



1/4"	820-002-176
3/8"	820-002-187
1/2"	820-002-198
5/8"	820-002-209
3/4"	820-002-220
7/8"	820-002-231
1"	820-002-242
1 1/8"	820-002-253
1 1/4"	820-002-264
1 3/8"	820-002-275
1 1/2"	820-002-286
1 5/8"	820-002-297
1 3/4"	820-002-308
1 7/8"	820-002-319
2"	820-002-330
2 1/8"	820-002-341

FORSTNER BIT SET

16 PC. 1/4" THRU 2-1/8"
3/8" SHANK
820-002-345



STEP DRILL

FOR POCKET SCREWS
3/8" x 7"
820-002-721



HINGE CUP BIT

35MM X 57.5MM RH
CARBIDE TIPPED
820-002-352



DOWEL BIT

57.5MM
CARBIDE TIPPED



5MM RH	820-002-377
5MM LH	820-002-379
8MM RH	820-002-363
8MM LH	820-002-374
10MM RH	820-002-382
10MM LH	820-002-383

PLUG CUTTERS

1/2" SHANK



3/8"	820-002-385
1/2"	820-002-396
5/8"	820-002-407
3/4"	820-002-418
1"	820-002-429

BRAD POINTS, TAPER BITS,
AND SELF-CENTERING BITS
ON PAGE 85

DIGITAL ANGLE FINDER

10 1/4" x 2" x 1"
RANGE 0°-360°
ACCURACY ± 0.05°
820-002-599



DIGITAL ANGLE GAUGE

RANGE ±90° x 4
ACCURACY ± 0.1°
820-002-597



DIGITAL HEIGHT GAUGE

RANGE 0-3 1/8"
ACCURACY ± 0.004"
820-002-600



STRAIGHT EDGE CLAMPS

USE AS A CLAMP. USE AS A GUIDE FOR YOUR
SAW. USE AS A FENCE ON YOUR
ROUTER TABLE.

24"	820-002-539
36"	820-002-541
50"	820-002-550



Valencia
Lumber and Panel

15809 STRATHERN STREET • VAN NUYS CA • 91406

818-786-5800

SALES@VALENCIALUMBER.COM

WWW.VALENCIALUMBER.COM



CMT ORANGE TOOLS

VENEER/LAMINATE SLITTER

820-002-605



A VERY USEFUL HAND TOOL FOR CLEAN, SPLINTER-FREE CUTS ON LAMINATES AND VENEERS WITH NO WASTE. PLACE YOUR MATERIAL INTO THE FENCE PROVIDED AND HAVE THE CUTTER RUN ALONG THE EDGE OF THE PANEL. THE TWO OPPOSING STEEL CIRCULAR CUTTING BLADES MOUNTED ON ROLLER BEARINGS WILL TRACE THE CUTTING LINE. USE THE MICROMETER KNOB ON THE TOP OF THE TOOL TO SET THE CUTTING THICKNESS, OR ADJUST THE STRIP WIDTH BY USING THE METRIC/INCH SCALE PROVIDED. LOOSEN THE LOCK KNOB ON THE SCALE, MOVE THE METAL BRACKET WHICH HOLDS THE FENCE AND TIGHTEN THE LOCK KNOB AGAIN ON THE DESIRED CUTTING WIDTH.

CUTTING WIDTH 1/2" TO 4-1/4"
THICKNESS UP TO 5/64"

BLADE & BIT CLEANER

AND BBQ'S TOO!

18 OZ SPRAY
820-002-528

GET THE MOST OUT OF YOUR CUTTING TOOLS WITH THIS NON-TOXIC FORMULA THAT REMOVES ALL PITCH AND RESIDUE ON BLADES AND BITS. INCREASES PERFORMANCE, LIFE, AND FREQUENCY BETWEEN SHARPENING. AND BECAUSE IT'S NON-TOXIC, IT ALSO MAKES ONE OF THE BEST BBQ CLEANERS AVAILABLE!



DOUBLE EDGED TRIMMER

820-002-583

REPLACEMENT KNIVES
820-002-594



ATTACH THIS TRIMMER TO YOUR WORKPIECE, PRESS BOTH ENDS AGAINST THE BOARD FOR A CUTTING RANGE BETWEEN 1/2" AND 1". MOVE THE TRIMMER IN THE CORRECT DIRECTION INDICATED BY THE ARROW. THIS WILL CUT ON BOTH SIDES EASILY. THE FIRST CUTTER WILL CUT STRAIGHT, THE SECOND ONE CAN BE ADJUSTED FOR A TAPERING CUT.



Valencia
Lumber and Panel

15809 STRATHERN STREET • VAN NUYS CA • 91406



818-786-5800



SALES@VALENCIALUMBER.COM



WWW.VALENCIALUMBER.COM



